

MEDICAL WASTE MANAGEMENT



ICRC



ICRC

International Committee of the Red Cross
19, avenue de la Paix
1202 Geneva, Switzerland
T +41 22 734 60 01 F +41 22 733 20 57
E-mail: shop@icrc.org www.icrc.org
© ICRC, November 2011

MEDICAL WASTE MANAGEMENT

TABLE OF CONTENTS

| | |
|---|----|
| PREFACE | 6 |
| 1. INTRODUCTION | 8 |
| 2. DEFINITION AND DESCRIPTION OF “MEDICAL WASTE” | 11 |
| 2.1 Description of medical waste | 12 |
| 2.2 Quantification of medical waste | 14 |
| 3. MEDICAL WASTE RISKS AND IMPACT ON HEALTH AND THE ENVIRONMENT | 15 |
| 3.1 Persons potentially exposed | 16 |
| 3.2 Risks associated with hazardous medical waste | 17 |
| 3.2.1 Risks of trauma and infection | 17 |
| 3.2.2 Survival of micro-organisms in the environment | 19 |
| 3.2.3 Biological risks associated with exposure to solid household refuse | 21 |
| 3.2.4. Chemical risks | 21 |
| 3.3 Risks associated with the inappropriate processing and dumping of hazardous medical waste | 24 |
| 3.3.1. Incineration risks | 24 |
| 3.3.2. Risks related to random disposal or uncontrolled dumping | 25 |
| 3.3.3. Risks related to the discharge of raw sewage | 25 |
| 4. LEGISLATION | 27 |
| 4.1 International agreements | 28 |
| 4.2 National Legislation | 30 |

| | |
|--|----|
| 5. FUNDAMENTAL PRINCIPLES OF A WASTE MANAGEMENT PROGRAMME | 33 |
| 5.1 Assigning responsibilities | 34 |
| 5.2 Sub-contracting, regional cooperation | 37 |
| 5.3 Initial assessment | 37 |
| 5.4 Preparing the waste management plan | 38 |
| 5.5 Estimating costs | 39 |
| 5.6 Implementing the waste management plan | 40 |
| 6. MINIMIZATION, RECYCLING | 41 |
| 7. SORTING, RECEPTACLES AND HANDLING | 45 |
| 7.1 Sorting principles | 46 |
| 7.2 How to sort waste | 47 |
| 7.3 Handling of bags | 50 |
| 8. COLLECTION AND STORAGE | 51 |
| 9. TRANSPORT | 53 |
| 9.1 Vehicles and means of conveyance | 54 |
| 9.2 On-site transport | 55 |
| 9.3 Off-site transport | 56 |
| 9.4 Cross-border transport | 56 |

| | |
|--|----|
| 10. TREATMENT AND DISPOSAL | 57 |
| 10.1 Choosing treatment and disposal methods | 58 |
| 10.2 Incineration | 62 |
| 10.3 Chemical disinfection | 68 |
| 10.4 Autoclaving | 69 |
| 10.5 Needle extraction or destruction | 71 |
| 10.6 Shredders | 73 |
| 10.7 Encapsulation | 74 |
| 10.8 Disposal in a sanitary landfill or waste burial pit | 75 |
| 10.9 Disposal of liquid wastes in the sewage | 77 |
| 11. STAFF PROTECTION MEASURES | 79 |
| 11.1 Personal protective equipment | 81 |
| 11.2 Personal hygiene | 83 |
| 11.3 Vaccination | 84 |
| 11.4 Measures to be taken in the event of accidental exposure to blood | 84 |
| 11.5 Emergency measures in the event of spills or contamination of surfaces | 86 |
| 11.6 Emergency measures in the event that persons have been contaminated | 88 |
| 12. TRAINING | 89 |
| 12.1 Why and how | 90 |
| 12.2 Content | 91 |
| 13. FURTHER INFORMATION | 93 |

| | |
|--|-----|
| ANNEX 1 WASTE DATA SHEETS | 95 |
| Data sheet no. 1: Sharps (category 1) | 96 |
| Data sheet no. 2: Waste entailing risk of contamination (category 2.a) | 98 |
| Data sheet no. 3: Anatomical waste (category 2.b) | 100 |
| Data sheet no. 4: Infectious waste (category 2.c) | 102 |
| Data sheet no. 5: Pharmaceutical waste (category 3.a) | 104 |
| Data sheet no. 6: Cytotoxic waste (category 3.b) | 106 |
| Data sheet no. 7: Mercury waste (category 3.c) | 108 |
| Data sheet no. 8: Photographic development liquids (category 3.d) | 110 |
| Data sheet no. 9: Chemical waste (category 3.d) | 112 |
| Data sheet no. 10: Pressurized containers (category 4) | 114 |
| Data sheet no. 11: Radioactive waste (category 5) | 116 |
| | |
| ANNEX 2 METHOD DATA SHEETS | 117 |
| Data sheet 12: Choosing sharps containers | 118 |
| Data sheet 13: Burial pit | 120 |
| Data sheet 14: Burial pit for anatomical waste | 122 |
| Data sheet 15 : Sharps pit | 124 |
| | |
| ANNEX 3 TOOLS FOR IMPLEMENTING THE WASTE MANAGEMENT PLAN | 127 |
| Annex 3.1 Example of a form for quantifying waste generation | 128 |
| Annex 3.2 Checklist for describing the current situation | 129 |
| Annex 3.3 Example of a waste flow diagram | 134 |
| Annex 3.4 Audit checklist | 135 |
| Annex 3.5 International transport of dangerous goods by road | 145 |
| Annex 3.6 Example of a poster: What to do in the event of AEB | 150 |
| | |
| ANNEX 4 LIST OF SYMBOLS AND PICTOGRAMS | 151 |
| | |
| LIST OF TABLES AND FIGURES | 156 |
| | |
| LIST OF ABBREVIATIONS | 158 |

PREFACE

The world is generating more and more waste and hospitals and health centres are no exception. Medical waste can be infectious, contain toxic chemicals and pose contamination risks to both people and the environment. If patients are to receive health care and recover in safe surroundings, waste must be disposed of safely.

Choosing the correct course of action for the different types of waste and setting priorities are not always straightforward, particularly when there is a limited budget. This manual provides guidance on what is essential and what actions are required to ensure the good management of waste.

Drawing on the most up-to-date professional practice, the manual provides practical recommendations for use in the different contexts where the ICRC works. It includes technical sheets ready for use, ideas for training and examples of job descriptions for hospital staff members. The guidance in this manual is applicable in resource poor countries as well as in countries where there is a more developed health infrastructure.

The management of the waste from health services is complex and to be successful it must be understood and addressed by everyone working in health services from those washing the floors to the senior administrators. We hope that this manual will convince readers that the management of medical waste is an essential component of health facilities that must be a priority shared by ICRC staff and our valued partner organisations.

Translating best practice for very different environments into clear and concise guidance for use by different professions is a rare skill. This manual would not have been possible without the expertise of Sylvie Praplan who has been the main partner and advisor in this adventure. Thanks are also due to the expertise of many staff working in the field and in the Headquarters of the ICRC and in particular to Margrit Schäfer, in charge of Hospital Administration and Martin Gauthier, Environmental Engineer, for their perseverance and guidance throughout the process.

Elizabeth Twinch

Head of Assistance Division
International Committee of the Red Cross

1. INTRODUCTION

Health-care activities are a means of protecting health, curing patients and saving lives. But they also generate waste, 20 percent of which entail risks either of infection, of trauma or of chemical or radiation exposure.

Although the risks associated with hazardous medical waste and the ways and means of managing that waste are relatively well known and described in manuals and other literature, the treatment and elimination methods advocated require **considerable technical and financial resources and a legal framework, which are often lacking** in the contexts in which the International Committee of the Red Cross (ICRC) works. The staff is often unequipped for coping with this task.

Poor waste management can jeopardize care staff, employees who handle medical waste, patients and their families, and the neighbouring population. In addition, the inappropriate treatment or disposal of that waste can lead to environmental contamination or pollution.

In unfavourable contexts, the risks associated with hazardous medical waste can be significantly reduced through simple and appropriate measures. This manual is intended as a **practical and pragmatic tool** for the routine management of dangerous hospital wastes. It does not under any circumstances replace any existing national waste management legislation and plans.

Hospitals are responsible for the waste they produce. They must ensure that the handling, treatment and disposal of that waste will not have harmful consequences for public health or the environment.

This manual is designed for the medical, technical or administrative staff working in medium-sized hospitals (approximately 100-bed capacity) that are managed or supported by the ICRC.

The manual includes data sheets in the Annex. It deals with wastes that are created in the course of surgical, medical, laboratory and radiological activities with the exception of specialties such as oncology, nuclear medicine or prosthetic/orthotic workshops. It deals mainly with so-called hazardous or special medical waste except for genotoxic waste such as cytotoxic substances or radioactive material, which are wastes that ICRC health care activities generally do not produce.

2. DEFINITION AND DESCRIPTION OF “MEDICAL WASTE”

2.1 **Description of medical waste**

The term “medical waste” covers all wastes produced in health-care or diagnostic activities.

75% to 90% of hospital wastes are similar to household refuse or municipal waste and do not entail any particular hazard.

Refuse similar to household waste can be put through the same collection, recycling and processing procedure as the community’s municipal waste. The other 10% to 25% is called hazardous medical waste or special waste. This type of waste entails health risks.

It can be divided into five categories according to the risks involved. Table 2.1 gives a description of those various categories and their sub-groups.

Table 2.1 **Classification of hazardous medical waste**

| | | |
|----|---|--|
| 1. | Sharps | → Waste entailing risk of injury. |
| 2. | <p>a. Waste entailing risk of contamination</p> <p>b. Anatomical waste</p> <p>c. Infectious waste</p> | <p>→ Waste containing blood, secretions or excreta entailing a risk of contamination.</p> <p>→ Body parts, tissue entailing a risk of contamination</p> <p>→ Waste containing large quantities of material, substances or cultures entailing the risk of propagating infectious agents (cultures of infectious agents, waste from infectious patients placed in isolation wards).</p> |
| 3. | <p>a. Pharmaceutical waste</p> <p>b. Cytotoxic waste</p> <p>c. Waste containing heavy metals</p> <p>d. Chemical waste</p> | <p>→ Spilled/unused medicines, expired drugs and used medication receptacles.</p> <p>→ Expired or leftover cytotoxic drugs, equipment contaminated with cytotoxic substances.</p> <p>→ Batteries, mercury waste (broken thermometers or manometers, fluorescent or compact fluorescent light tubes).</p> <p>→ Waste containing chemical substances: leftover laboratory solvents, disinfectants, photographic developers and fixers.</p> |
| 4. | Pressurized containers | → Gas cylinders, aerosol cans. |
| 5. | Radioactive waste | → Waste containing radioactive substances: radionuclides used in laboratories or nuclear medicine, urine or excreta of patients treated. |

The various categories of waste are set out in detail in the data sheets in Annex 1 (sheets 1 to 11). Cytotoxic and radioactive wastes are dealt with briefly in that annex.

2.2 **Quantification of medical waste**

The quantity of waste produced in a hospital depends on the level of national income and the type of facility concerned. A university hospital in a high-income country can produce up to 10 kg of waste per bed per day, all categories combined.

An ICRC hospital with 100 beds will produce an average of 1.5 to 3 kg of waste per patient per day depending on the context (all categories combined and including household refuse).

An estimate of the quantities of waste produced must be drawn up in each facility (see chapter 5.3 and Annex 3.1).

3. MEDICAL WASTE RISKS AND IMPACT ON HEALTH AND THE ENVIRONMENT

3.1 **Persons potentially exposed**

All persons who are in contact with hazardous medical waste are potentially exposed to the various risks it entails: persons inside the establishment generating the waste, those who handle it, and persons outside the facility who may be in contact with hazardous wastes or their by-products, if there is no medical waste management or if that management is inadequate.

The following groups of persons are potentially exposed:

- Inside the hospital: care staff (doctors, nursing staff, auxiliaries), stretcher-bearers, scientific, technical and logistic personnel (cleaners, laundry staff, waste managers, carriers, maintenance personnel, pharmacists, laboratory technicians, patients, families and visitors).
- Outside the hospital: off-site transport personnel, personnel employed in processing or disposal infrastructures, the general population (including adults or children who salvage objects found around the hospital or in open dumps).

3.2 Risks associated with hazardous medical waste

The health risks associated with hazardous medical waste can be divided into five categories:

- risk of trauma
(waste category 1);
- risk of infection
(waste categories 1 and 2);
- chemical risk
(waste categories 3 and 4);
- risk of fire or explosion
(waste categories 3 and 4);
- risk of radioactivity
(waste category 5, which is not dealt with in this manual).

The risk of environmental pollution and contamination must be added to these categories.

3.2.1 RISKS OF TRAUMA AND INFECTION

Health-care wastes are a source of potentially dangerous micro-organisms that can infect hospital patients, personnel and the general public. There are many different exposure routes: through injury (cut, prick), through contact with the skin or mucous membranes, through inhalation or through ingestion.

Table 3.1 gives examples of infections that can be caused by hazardous medical waste.

Table 3.1 **Examples of infections that can be caused by hazardous medical waste¹**

| Type of infection | Infective agent | Transmission agent |
|------------------------------------|---|--|
| Gastrointestinal infections | Enterobacteria (<i>Salmonella</i> , <i>Vibrio cholerae</i> , <i>Shigella</i> , etc.) | Faeces, vomit |
| Respiratory infections | <i>Mycobacterium tuberculosis</i> , <i>Streptococcus pneumoniae</i> , SARS virus (Severe Acute Respiratory Syndrome), measles virus | Inhaled secretions, saliva |
| Eye infections | Herpes virus | Eye secretions |
| Skin infections | <i>Streptococcus</i> | Pus |
| Anthrax | <i>Bacillus anthracis</i> | Skin secretions |
| Meningitis | <i>Neisseria meningitidis</i> | Cerebro-spinal fluid |
| AIDS | Human Immunodeficiency Virus (HIV) | Blood, sexual secretions, other body fluids |
| Haemorrhagic fever | Lassa, Ebola, Marburg, and Junin viruses | Blood and secretions |
| Viral hepatitis A | Hepatitis A virus | Faeces |
| Viral hepatitis B and C | Hepatitis B and C viruses | Blood and other biological fluids |
| Avian influenza | H5N1 virus | Blood, faeces |

Some accidental exposure to blood (AEB) or to other body fluids are examples of accidental exposure to hazardous medical waste.

¹ Source: A. Prüss, E. Giroult, and P. Rushbrook, *Safe management of wastes from health-care activities*, WHO, 1999.

As regards viral infections such as AIDS and hepatitis B and C, it is nursing staff who are most at risk of infection through contaminated needles. Sharps and pathogenic cultures are regarded as the most hazardous medical waste.

In 2000, the World Health Organisation (WHO) estimated that at world level accidents caused by sharps accounted for 66,000 cases of infection with the hepatitis B virus, 16,000 cases of infection with hepatitis C virus and 200 to 5,000 cases of HIV infection amongst the personnel of health-care facilities.

Some wastes, such as anatomical wastes, do not necessarily entail a health risk or risk for the environment but must be treated as special wastes for ethical or cultural reasons.

A further potential risk is that of the propagation of micro-organisms outside health-care facilities which are present in those facilities and which can sometimes be resistant – a phenomenon that has not yet been sufficiently studied.

3.2.2 SURVIVAL OF MICRO-ORGANISMS IN THE ENVIRONMENT

Pathogenic micro-organisms have a limited capacity of survival in the environment. Survival depends on each micro-organism and on environmental conditions (temperature, humidity, solar radiation, availability of organic substrate, presence of disinfectants, etc.). Bacteria are less resistant than viruses. Very little is known as yet about the survival of prions and the agents of degenerative neurological diseases (such as Creutzfeldt-Jakob's disease, Kuru, and so on), which seem to be more resistant than viruses.

Table 3.2 gives a summary of what is known about the survival of various pathogens.

Table 3.2: **Examples of the survival time of certain pathogens²**

| Pathogenic micro-organism | Observed survival time |
|---|---|
| Hepatitis B virus | <ul style="list-style-type: none"> → Several weeks on a surface in dry air → 1 week on a surface at 25°C → Several weeks in dried blood → 10 hours at 60°C → Survives 70% ethanol. |
| Infectious dose of hepatitis B and C viruses | → 1 week in a drop of blood in a hypodermic needle |
| Hepatitis C | → 7 days in blood at 4°C. |
| HIV | <ul style="list-style-type: none"> → 3 – 7 days in ambient air → Inactivated at 56°C → 15 minutes in 70% ethanol → 21 days in 2 µl of blood at ambient temperature → Drying the virus reduces its concentration by 90-99% within the next few hours. |

The concentration of micro-organisms in medical waste, with the exception of laboratory cultures of pathogens and the excreta of infected patients, is generally no higher than in household refuse. However, medical waste contain a wider variety of micro-organisms.

On the other hand, the survival time of the micro-organisms present in medical waste is short (probably because the wastes contain disinfectants).

The role played by carriers such as rats and insects must also be taken into account in the evaluation of micro-organism survival time in the environment. They are passive carriers of pathogens, and measures must be taken to control their proliferation.

² WHO 2010, Public Health Agency of Canada 2001, Thomson *et al.* 2003.

3.2.3 **BIOLOGICAL RISKS ASSOCIATED WITH EXPOSURE TO SOLID HOUSEHOLD REFUSE**

Since exposure conditions are often the same for employees dealing with household refuse and those dealing with medical waste, the impact on the health of the former can be used as an indicator for the latter.

Various studies conducted in high-income countries have shown the following results:

Compared to the general population, in the case of persons employed in the processing of household waste

- the risk of infection is 6 times higher;
- the risk of contracting an allergic pulmonary disease is 2.6 times higher;
- the risk of contracting chronic bronchitis is 2.5 times higher;
- and the risk of contracting hepatitis is 1.2 times higher.

Pulmonary diseases and bronchitis are caused by exposure to the bio-aerosols contained in the air at the sites where the refuse is dumped, stored or processed.³

3.2.4. **CHEMICAL RISKS**

Many chemical and pharmaceutical products are used in health-care facilities. Most of them entail a health risk due to their properties (toxic, carcinogenic, mutagenic, reprotoxic, irritant, corrosive, sensitizing, explosive, flammable, etc.). There are various exposure routes for contact with these substances: inhalation of gas, vapour or droplets, contact with the skin or mucous membranes, or ingestion. Some substances (such as chlorine and acids) are incompatible and can generate toxic gases when mixed.

³ These bio-aerosols contain gram-positive and gram-negative bacteria, aerobic Actinomycetes and sewage fungi.

The identification of potential hazards caused by certain substances or chemical preparations can be easily done through labelling: symbols, warning statements or hazard statements. More detailed information is set out in the material safety data sheet (MSDS).

Some examples of the European and international hazard symbols are shown in Annex 4. Figures 3.1 and 3.2 give examples of European and international labelling (Globally Harmonized System - GHS).

Cleaning products and, in particular, disinfectants are examples of dangerous chemicals which are used in large quantities in hospitals. Most are irritant or even corrosive, and some disinfectants (such as formaldehyde) can be sensitizing and toxic.



| | | | |
|---|--|---|---|
|  | Acetone | <p>R11 Highly flammable.</p> <p>R36 Irritating to the eyes.</p> <p>R66 Repeated exposure may cause skin dryness or cracking.</p> <p>R67 Vapours may cause drowsiness and dizziness.</p> | Risk statements (R-statements) |
| <p>F - Highly flammable</p> | | | |
|  | <p>S9 Keep container in a well-ventilated place.</p> <p>S16 Keep away from sources of ignition – No smoking.</p> <p>S26 In case of contact with eyes, rinse immediately with plenty of water and seek medical advice.</p> <p>S46 If swallowed, seek medical advice immediately and show this container or label.</p> | Precautionary statements (P-statements) | |
| <p>Xi - Irritant</p> | | | |
| <p>Name, address and telephone number of the firm responsible in Switzerland.</p> | | | |

Figure 3.1: Example of the labelling of chemicals (European system applicable until 2015)



| | | | |
|---|---|---|--|
|  | Acetone | | Hazard statements (H-statements) |
| | H225 | Highly flammable liquid and vapour. | |
| | H319 | Causes serious eye irritation. | |
| H335 | May cause drowsiness or dizziness. | | |
| EUHD55 | Repeated exposure may cause skin dryness or cracking. | | |
|  | P210 | Keep away from heat/sparks/open flames/hot surfaces – No smoking. | Precautionary statements (P-statements) |
| | P361 | Avoid breathing vapours. | |
| | P403/ 333 | Store in a well-ventilated place. Keep container tightly closed. | |
| | P305/ 351/ 338 | If in eyes: Rinse carefully with water for several minutes. Remove contact lenses if present and easy to do – continue rinsing. | |
| | Name, address and telephone number of the firm responsible in Switzerland. | | |

Figure 3.2: Example of the labelling of chemicals according to the new (international) system (GHS)

Mercury is a heavy metal in liquid form at room temperature and pressure. It is very dense (1 litre of mercury weighs 13.5 kg!). It evaporates readily and can remain for up to a year in the atmosphere. It accumulates in sediments, where it is converted into methylmercury, a more toxic organic derivative. Mercury is found mainly in thermometers, manometers, dental alloys, certain types of battery, electronic components and fluorescent or compact fluorescent light tubes. Health-care facilities are one of the main sources of mercury in the atmosphere due to the incineration of medical waste. These facilities are also responsible for the mercurial pollution of surface water.

Mercury is highly toxic. There is no threshold under which it does not produce any undesirable effect.

Mercury can cause fatal poisoning when inhaled.⁴ It is also harmful in the event of transcutaneous absorption and has dangerous effects on pregnancy.

Silver is another toxic element that is found in hospitals (photographic developers). It is bactericidal. Bacteria which develop resistance to silver are also thought to be resistant to antibiotics.⁵

The trading and use of expired medicines also entail a public health risk whenever this type of waste is not controlled. This manual does not cover the risk associated with cytotoxic drugs (see information outlined in Annex 1 – data sheet no. 6).

3.3 **Risks associated with the inappropriate processing and dumping of hazardous medical waste**

3.3.1. **INCINERATION RISKS**

In some cases, particularly when wastes are incinerated at low temperature (less than 800°C) or when plastics containing polyvinyl chloride (PVC) are incinerated, hydrochloric acid (which causes acid rain), dioxins, furans and various other toxic air-borne pollutants are formed. They are found in emissions but also in residual and other air-borne ash and in the effluent gases released through incinerator chimneys. Exposure to dioxins, furans and other coplanar polychlorinated biphenyls can have effects that are harmful to public health.⁶

4 The disease caused by exposure to mercury is called mercurialism.

5 Anon 2007, Chopra 2007, Senjen & Illuminato 2009.

6 Long-term exposure to low doses of dioxins and furans can result in immune system disorders in humans as well as abnormal development of the nervous system, endocrine disruption and reproductive damage. Short-term exposure to high doses can cause skin lesions and impaired liver function. The International Agency for Research on Cancer (IARC) classes dioxins as known human carcinogens.

These substances are persistent, that is to say, the molecules do not break down in the environment and they accumulate in the food chain. The bulk of human exposure to dioxins, furans and coplanar polychlorinated biphenyls takes place through food intake.

Even in high-temperature incinerators (over 800°C) there are cooler pockets at the beginning or the end of the incineration process where dioxins and furans can form. Optimization of the process can reduce the formation of these substances if it is ensured, for example, that incineration takes place only at temperatures above 800°C and if the formation of combustion gas is prevented at temperatures of 200 - 400°C (see good incineration practices in Chapter 10.2).

And lastly, the incineration of metals or of materials with a high metal content (especially lead, mercury and cadmium) can result in metals being released into the environment.

3.3.2. RISKS RELATED TO RANDOM DISPOSAL OR UNCONTROLLED DUMPING

In addition to the above-mentioned risks, burial and random dumping on uncontrolled sites can have a direct impact on the environment in terms of soil and water pollution.

3.3.3. RISKS RELATED TO THE DISCHARGE OF RAW SEWAGE

Poor management of wastewater and sewage sludge can result in the contamination of water and soil with pathogens or toxic chemicals.

Pouring chemical and pharmaceutical wastes down the drain can impair the functioning of biological sewage treatment plants or septic tanks. These can end up polluting the ecosystem and water sources. Antibiotics and their metabolites are excreted in the urine and faeces of

patients under treatment and end up in sewage. Hospital sewage contains 2 to 10 times more antibiotic-resistant bacteria than domestic wastewater, a phenomenon which contributes to the emergence and propagation of pathogens such as MRSA (methicillin-resistant *Staphylococcus aureus*).

4. LEGISLATION

4.1 **International agreements**

Several international agreements have been concluded which lay down fundamental principles concerning public health, environmental protection and the safe management of hazardous wastes. These principles and conventions are set out below and must be taken into account in the planning of hazardous medical waste management.

Basel Convention on the Control of Transboundary Movements of Hazardous Wastes and Their Disposal (UNEP, 1992)

The main objectives of the Basel Convention are to minimize the generation of hazardous wastes, treat those wastes as close as possible to where they were generated and reduce transboundary movements of hazardous wastes.

It stipulates that the only case where the cross-border movement of hazardous waste is legitimate is the export of waste from a country which does not have the expertise or the infrastructure for safe disposal to a country which does.

Bamako Convention (1991)

This treaty banning the importation of any hazardous wastes into Africa has been signed by 12 nations.

Stockholm Convention on Persistent Organic Pollutants (UNEP, 2004)

This convention aims to reduce the production and use of persistent organic pollutants and to eliminate uncontrolled emissions of substances such as dioxins and furans.

Polluter pays principle

Any producer of waste is legally and financially liable for disposing of that waste in a manner that is safe for people and the environment (even if some of the processes are sub-contracted).

Precautionary principle

When the risk is uncertain it must be regarded as significant and protective measures must be taken accordingly.

Proximity principle

Hazardous wastes must be treated and disposed of as close as possible to where they are produced.

Agenda 21 (plan of action for the 21st century adopted by 173 heads of State at the Earth Summit held in Rio in 1992)

To minimize the generation of waste, to re-use and recycle, treat and dispose of waste products by safe and environmentally sound methods, placing all residue in sanitary landfills.

WHO and UNEP initiatives concerning mercury and Decision VIII/33 of the Conference of the Parties to the Basel Convention on mercury wastes

Measures should be taken as soon as possible to identify populations at risk of exposure to mercury and to reduce anthropogenic wastes. The WHO is ready to guide countries in implementing a long-term strategy to ban appliances containing mercury.

The ISWA⁷ (International Solid Waste Association) is an international network of waste treatment and management experts. Its purpose is to exchange information with a view to promoting modern waste management strategies and environmentally sound disposal technologies. The ISWA is currently active in over 20 countries with some 1200 members throughout the world.

⁷ <http://www.iswa.org>

4.2 National Legislation

National legislation constitutes a basis which must be drawn on to improve waste treatment practices in a country. Many countries are currently drawing up national medical waste management plans. The Global Alliance for Vaccines and Immunization (GAVI) has been financing a project in collaboration with the WHO in this context since 2006, the aim being to help 72 countries adopt a policy, strategy and plan for managing the wastes generated in health-care activities.

The following countries are concerned:

Africa

Angola, Benin, Burkina Faso, Burundi, Cameroon, Chad, Comoros, Congo, Central African Republic, Côte d'Ivoire, Eritrea, Ethiopia, Gambia, Ghana, Guinea, Guinea Bissau, Kenya, Lesotho, Liberia, Madagascar, Malawi, Mali, Mauritania, Mozambique, Niger, Nigeria, Uganda, Rwanda, Senegal, Sierra Leone, Somalia, Sudan, Tanzania, Togo, Zambia, Zimbabwe.

South America

Bolivia, Cuba, Guyana, Haiti, Honduras, Nicaragua.

Middle East:

Afghanistan, Djibouti, Pakistan, Yemen.

Europe

Armenia, Azerbaijan, Kyrgyzstan, Georgia, Moldavia, Uzbekistan, Tajikistan, Ukraine.

Asia

Bangladesh, Bhutan, Cambodia, Democratic People's Republic of Korea, India, Indonesia, Laos, Mongolia, Myanmar, Nepal, Solomon Islands, Sri Lanka, Timor-Leste, Viet Nam.

The ICRC will have to investigate these various measures. Other national legislative provisions will have to be taken into account in the medical waste management context:

- general legislation on waste;
- legislation on public health and environmental protection;
- legislation on air and water quality;
- legislation on the prevention and control of infections;
- legislation on radiation protection;
- legislation on the transport of hazardous substances;
- occupational safety and health legislations and regulations.

5. FUNDAMENTAL PRINCIPLES OF A WASTE MANAGEMENT PROGRAMME

5.1 Assigning responsibilities

The proper management of medical waste depends on good organization, sufficient funding and the active participation of informed and trained personnel. Those are the preconditions for the consistent application of measures throughout the waste chain (from where it is generated to where it is eventually disposed of).

Only too often, waste management is relegated to the rank of a menial task, whereas it ought to be valued and all actors in a hospital made to realize their share of responsibility.

A “waste management” working group must thus be set up by the hospital manager. That team must include the following members: the hospital project manager, the water and habitat engineer, the local waste manager, and members of the hospital staff, such as the hospital administrator, the head nurse, the head of radiology, the chief pharmacist and the head of laboratory.

Duties of the hospital project manager

The hospital project manager has the overall responsibility of ensuring that the hospital wastes are managed in compliance with national legislation and international conventions. He is also responsible for:

- setting up a working group in charge of drafting the waste management plan;
- appointing the local waste manager, who will supervise and coordinate the waste management plan on a daily basis;
- assigning duties; drawing up job descriptions;
- allocating financial and human resources;
- implementing the waste disposal plan;
- conducting audits and continuously updating and improving the waste management system.

Duties of the water and habitat engineer

The water and habitat engineer is responsible for:

- carrying out an initial assessment of the waste situation;
- proposing a waste management plan to the working group (including the choice of treatment/disposal methods) that is in line with any existing national waste management plan;
- planning the construction and maintenance of waste storage and disposal facilities;
- assessing the environmental impact of waste management (monitoring contamination, conducting hydrogeological assessments, etc.);
- regularly analysing risks for the personnel;
- supervising the local waste manager;
- training.

Duties of the local waste manager

The local waste manager is the person in charge of administering the waste management plan on a daily basis. He⁸ is the guarantor of the long-term sustainability of the system and must thus be in direct contact with all the members of the working group and all hospital employees. His duties include:

- monitoring the collection, storage and transport of wastes on a daily basis;
- monitoring the stocks of receptacles and containers, bags and personal protective equipment as well as the maintenance of the means of transport used; forwarding orders to the hospital administrator;
- supervising the persons in charge of collecting and transporting wastes;
- monitoring the measures to be taken in the event of an accident (posting notices, informing the staff);
- monitoring protective measures;
- investigating incidents/accidents involving wastes;

⁸ For the sake of simplicity and easier reading, the masculine form is used throughout. It is to be understood as including women exercising the various professions.

- drawing up reports (quantities of waste produced, incidents);
- ensuring the maintenance of storage and treatment facilities.

Duties of the hospital administrator

The hospital administrator is responsible for:

- ensuring that stocks of consumables (bags, receptacles and containers, personal protective equipment, etc.) are permanently available;
- examining and evaluating costs;
- drawing up contracts with third parties (carriers, sub-contractors);
- giving advice on purchasing policies with a view to minimize/substitute certain items (mercury-free equipment, PVC-free equipment, etc.);
- monitoring proper implementation of protective measures;
- supervising in the absence of the water and habitat engineer.

Duties of the head nurse

The head nurse is responsible for:

- training care staff in waste management (paying special attention to new staff members);
- monitoring sorting, collection, storage and transport procedures in the various wards;
- monitoring protective measures;
- supervising the hospital hygiene and taking measures to control infection.

Duties of the chief pharmacist

The chief pharmacist is responsible for:

- maintaining medicine stocks and minimizing expired stock;

Each person's responsibilities and duties must be assigned in writing.

- managing waste containing mercury.
- In the absence of the pharmacist, the hospital administrator takes over these responsibilities.

Duties of the head of laboratory

The head of laboratory is responsible for:

- maintaining the stock of chemicals and minimizing chemical wastes;
- managing chemical wastes.

5.2 Sub-contracting, regional cooperation

In certain circumstances the ICRC may have to choose a transport/treatment/disposal solution outside the hospital, either by requesting the services of a private company or by organizing cooperation amongst the health-care facilities in the region.

The hospital remains responsible under all circumstances for the wastes it produces and for their impact on persons or the environment.

The facility will thus have to call in companies qualified to handle special wastes and ensure that the treatment/disposal procedures followed by them are compatible with national legislation and international agreements.

5.3 Initial assessment

The first stage when drawing up a waste management plan is to carry out an initial assessment of needs and resources, that is, of describing the initial situation.

A checklist (Annex 3.2) can be used to describe the initial situation and resources. This stage involves making an inventory, and consists of gathering information on national waste policy and legislation, local waste management practices and the staff involved.

It will be up to the water and habitat engineer (or, in his/her absence, the hospital administrator) to draw up this inventory together with the members of the waste management group and the heads of department and also consulting the national authorities, where possible.

Form 3.1 (Annex 3) can be used to evaluate the quantity of waste produced by the hospital. The categories used must match those registered in the national directives (policies, legislations and regulations). Where there are no such directives, the waste categories set out in the present manual (Table 2.1) must be referred to. The purpose of this stage of the procedure is to determine the quantity of waste produced per category and per department.

5.4 **Preparing the waste management plan⁹**

A draft waste management plan will then have to be drawn up using the data that has been collected. It must contain the following chapters:

Table 5.1: **Tools for drafting the waste management plan**

| Stages | Tools |
|---|---|
| Inventory | Quantification of waste, Annex 3.1 Checklist for describing the current situation, Annex 3.2 |
| Minimization/recycling and purchasing policy | Chapter 6 |
| Sorting, collection, storage and transport | Chapters 7, 8 and 9 |
| Identification and evaluation of treatment/disposal options - Diagram of waste flows | Chapter 10 Example: Annex 3.3 |
| Protective measures | Chapter 11 |
| Training | Chapter 12 |
| Estimating costs | Section 5.5 |
| Implementation strategy | Section 5.6 |
| Audit and follow-up | Audit checklist, Annex 3.4 |

⁹ Further information can be found in the following publication: CEHA, *Basic steps in the preparation of health care waste management plans for health care establishments*, 2002, www.emro.who.int/ceha

A diagram of waste flows should summarize the sorting procedures and treatment chains for the various types of waste. An example of the system used in Lokichokio (Kenya – 2001) is included in Annex 3.3.

5.5 Estimating costs

Medical waste management costs vary widely depending on the context, the amount of waste generated and the treatment methods chosen. A WHO estimate dating from 2003 shows that in a small health-care facility the cost per kg of waste incinerated in a SICIM-type single-chamber incinerator can range from \$0,08/kg to \$1,36/kg.

The following factors must be taken into account in the cost estimate:¹⁰

→ Investment costs:

- cost of the land;
- cost of building/purchasing infrastructures (such as an incinerator, a storeroom, or a waste burial pit);
- vehicles;
- on-site means of transport (such as wheelbarrows);
- bag stands or containers;
- personal protective equipment (clothes, boots).

→ Operating costs

- fuel or electricity or water;
- spare parts, maintenance of treatment facilities;
- staff salaries;
- sharps containers and bags;
- vehicle maintenance;
- personal protective equipment (gloves, masks);
- training.

¹⁰ Tools for estimating costs: Health-care waste management. Costing Analysis Tool (CAT). Expanded Costing Analysis Tools (ECAT). <http://www.healthcarewaste.org>

5.6 **Implementing the waste management plan**

The hospital project manager is responsible for implementing the waste management plan. He can delegate certain tasks to the water and habitat engineer or the hospital administrator. The implementation of the plan includes the following steps:

- approval and signing of the waste management plan;
- allocation of resources;
- assignation of tasks;
- organization of training;
- regular audits and monitoring, on-going improvement of the waste management plan.

A sample checklist for audits is included in Annex 3.4.

6. MINIMIZATION, RECYCLING

The reduction of waste generation must be encouraged by the following practices:

- Reducing the amount of waste at source
 - Choosing products that generate less waste: less wrapping material, for example.
 - Choosing suppliers who take back empty containers for refilling (cleaning products); returning gas cylinders to the supplier for refilling.
 - Preventing wastage: in the course of care, for example, or of cleaning activities.
 - Choosing equipment that can be reused such as tableware that can be washed rather than disposable tableware.

It is prohibited to re-use needles or syringes.

The plastic part of syringes is recycled in some regions, but this practice is not recommended in ICRC contexts.

- Purchasing policy geared to minimizing risks
 - Purchase of PVC-free equipment (choosing PET, PE or PP) - see Health Care Without Harm site.¹¹
 - Purchase of mercury-free equipment: mercury-free thermometers (ICRC standards), mercury-free blood pressure gauges).
 - If possible, purchase of new safe injection and blood-sampling systems (where the needle is withdrawn automatically).
 - Opting for the least toxic products (cleaning products, for example).

¹¹ <http://www.noharm.org>

→ Product recycling

- Recycling of batteries, paper, glass, metals and plastic.
- Composting of plant waste (kitchen and garden wastes).
- Recycling of the silver used in photographic processing.
- Recovering energy for water heating for example.

→ Stock management

- Centralized purchasing.
- Chemical and pharmaceutical stock management aiming to avoid a build-up of expired or unused items: “first-in – first out” stock management, expiry date monitoring.
- Choice of suppliers according to how promptly they deliver small quantities and whether unused goods can be returned.

→ Sorting at source

Segregating waste is the best way to reduce the volume of hazardous wastes requiring special treatment.

7. SORTING, RECEPTACLES AND HANDLING

7.1 **Sorting principles**

Sorting consists of clearly identifying the various types of waste and how they can be collected separately. There are two important principles that must be followed:

Waste sorting must always be the responsibility of the entity that produces them. It must be done as close as possible to the site where the wastes are produced.

For example, the nursing staff must dispose of sharps in needle containers located as close as possible to the place where the needles are used so as to avoid any manipulation of used needles. Ideally, the nursing staff will take the needle container to the patient's bedside. Do not put the caps back on syringe needles or remove them from the syringe by hand! It is much too dangerous to do so.

Maintain sorting throughout the chain (in storage areas and during transport).

There is no point in sorting wastes that undergo the same treatment process, with the exception of sharps, which must at all times be separated at source from other wastes.





Sorting is a significant stage in waste management, which concerns all members of staff. Training, regular information and frequent checking are essential if the sustainability of the system that has been established is to be guaranteed.

Do not correct mistakes: if non-hazardous material has been placed in a container for wastes entailing the risk of contamination, that waste must now be considered hazardous (**precautionary principle**).

7.2 How to sort waste

The simplest way to identify the different types of waste and to encourage people to sort them is to collect the various types of waste in separate containers or plastic bags that are colour-coded and/or marked with a symbol. The international recommendations are as follows:

Table 7.1 **Coding recommendations (WHO – UNEP/SBC 2005)**

| Type of waste | Colour coding - symbol | Type of container |
|---|--|--|
| 0. Household refuse | Black | Plastic bag |
| 1. Sharps | Yellow and  | Sharps container |
| 2a. Waste entailing a risk of contamination 2b. Anatomical waste | Yellow and  | Plastic bag or container |
| 2c. Infectious waste | Yellow marked "highly infectious" and  | Plastic bag or container which can be autoclaved |
| 3. Chemical and pharmaceutical waste | Brown, marked with a suitable symbol (see Annex 4, chapter 4: Labelling of chemicals). E.g.:  | Plastic bag, container |

Setting up a 3-container sorting system (for sharps, potentially infectious waste and household refuse) is effective as a first step which is easy to do and provides a means of drastically reducing the major risks.

In an emergency, during victim triage it is strongly recommended that all wastes generated by this activity be considered wastes entailing a risk of contamination and should be stored in appropriate containers (containers equipped with yellow bags).

Household refuse, in black bags, must be put through the same treatment chain as municipal waste. But before this is done, recyclable waste and compostable materials must first be separated at source.

The criteria for choosing sharps containers are set out in detail in data sheet no. 12 (Annex 2). Photo 7.3 shows the sharps containers used by the ICRC.

The bags must be placed either in rigid containers or on castor-fitted stands (see photos 7.1 and 7.2). In certain circumstances, if no plastic bags are available, the containers must first be emptied, then washed and disinfected (with a 5% active chlorine solution).



Photo 7.1:
Container equipped with a black plastic bag (household refuse)



Photo 7.2:
Plastic bag stand on castors



Photo 7.3:
Sharps container (ICRC)

There must be an adequate stock of bags and containers wherever waste is produced. This is the responsibility of the local waste manager and the hospital administrator.

The following are the criteria for choosing plastic bags: appropriate size for the container and the quantity of waste produced, sufficiently thick (70 μm – ISO 7765 2004) and of suitable quality (tear-resistant), non-halogenated plastic (no PVC).

Anatomical waste cannot always be collected in yellow plastic bags for cultural or religious reasons. It must be treated in accordance with local customs (often buried).

Chemical and pharmaceutical wastes must be sorted and treated separately. The sub-categories include mercury wastes, light bulbs, batteries, photographic developers, laboratory chemicals, pesticides and medicines.

How to recognize PVC:
it sinks in water (is denser than water) and it produces a green flame when burnt.
PE and PP float.

7.3 Handling of bags

Bags and containers must be closed whenever they are two-thirds full. This is the responsibility of the nursing staff! Never pile bags or empty them; grasp them from the top (never hold them against the body) and wear gloves (see photo 7.4).



Photo 7.4:
Handling a bag of wastes

8. COLLECTION AND STORAGE

Waste must be collected regularly - at least once a day. It must never be allowed to accumulate where it is produced. A daily collection programme and collection round must be planned. Each type of waste must be collected and stored separately.

Infectious wastes (categories 1 and 2) must never be stored in places that are open to the public.

The personnel in charge of collecting and transporting wastes must be informed to collect only those yellow bags and sharps containers which the care staff have closed. They must wear gloves.

The bags that have been collected must be replaced immediately with new bags.

A specific area must be designated for storing medical waste and must meet the following criteria¹²:

- it must be closed, and access must be restricted to authorized persons only;
- it must be separate from any food store;
- it must be covered and sheltered from the sun;
- the flooring must be waterproof with good drainage;
- it must be easy to clean;
- it must be protected from rodents, birds and other animals;
- there must be easy access for on-site and off-site means of transport;
- it must be well aired and well lit;
- it must be compartmented (so that the various types of waste can be sorted);
- it must be near the incinerator, if incineration is the treatment method used;
- there must be wash basins nearby;
- the entrance must be marked with a sign ("No unauthorized access", "Toxic", or "Risk of infection" – see Annex 4, Sections 1 and 2).

The wastes can be stored for a week in a refrigerated area (3° to 8° C). Where there is no such refrigerated area, the storage time for infectious medical waste must not exceed the following limits:

- in temperate climates: 72 hours in winter and 48 hours in summer;
- in hot climates: 48 hours in the cool season and 24 hours in the hot season.

¹² See Table 7.1, *Safe management of wastes from health-care activities*, WHO, 1999. *Op. cit.*

9. TRANSPORT

9.1 Vehicles and means of conveyance

As far as possible, the means used for transporting waste must be reserved for that purpose, and different means must be used for each type of waste (e.g. one wheelbarrow for household refuse and another one for Type 1 or Type 2 medical waste). This is not always possible in the contexts where the ICRC works.

These means of conveyance must meet the following requirements:

- they must be easy to load and unload;
- they must not have any sharp corners or edges that might tear the bags or damage the containers;
- they must be easy to clean; (with a 5% active chlorine solution);
- they must be clearly marked.

Furthermore, off-site means of transport must meet the following requirements:

- they must be closed in order to avoid any spilling on the road;
- they must be equipped with a safe loading system (to prevent any spilling inside or outside the vehicle);
- they must be marked according to the legislation in force if the load exceeds 333 kg (see Annex 3.5).

The vehicles and means of conveyance must be cleaned daily.

9.2 On-site transport

Different means of conveyance may be used inside the facility – wheelbarrows, containers on wheels, carts (see photos 9.1 and 9.2).



Photo 9.1:
An example of an on-site
means of conveyance
(Lokichokio, 2001)



Photo 9.2:
An example of an on-site
means of conveyance
(container on wheels)

Inside the facility, wastes must be transported during slacker periods. The itinerary must be planned so as to avoid any exposure of staff, patients or the general public. It must run through as few clean zones (sterilization rooms), sensitive areas (operating theatres, intensive care units) or public areas as possible.

9.3 Off-site transport

The entity producing the waste is responsible for packaging and labelling the waste to be transported outside the hospital.

Packaging and labelling must be in conformity with national legislation on the transport of dangerous substances and with the Basel Convention in the case of cross-border transport. If there is no national legislation on the subject, the [United Nations] Recommendations on the Transport of Dangerous Goods¹³ or the European Agreement on the International Carriage of Dangerous Goods by Road (ADR)¹⁴ should be referred to.

If a vehicle is carrying less than 333 kg of medical waste entailing the risk of contamination (UN 3291), it is not required to be marked. Otherwise it must bear sign plates.

See Annex 3.5 for further information.

9.4 Cross-border transport

The Basel Convention lays down stringent regulations on the export of wastes. Enquiries must be made in each individual country as to the provisions in effect. In the case of Pakistan, for example, which is a signatory of the Basel Convention but has not ratified its amendments, the requirements are laid down in the Pakistan Environmental Protection Act – 1997.

According to the Basel Convention, the code for clinical wastes from medical care provided in hospitals, medical centres and clinics is Y1. The code for unwanted/unused drugs is Y3. And the code for wastes generated in the production, preparation and use of photographic products and materials is Y16.

Where the transport of these wastes is sub-contracted to an external firm, the ICRC must ensure that the carrier is authorized to handle hazardous substances and that it complies with the legislation in force. The organization must furthermore ensure that the wastes will be treated appropriately and safely at their destination.

¹³ Recommendations on the Transport of Dangerous Goods, sixteenth revised edition, 2009, http://www.unecce.org/trans/danger/publi/unrec/rev16/16files_e.html

¹⁴ <http://www.unecce.org/trans/danger/publi/adr/adr2009/09ContentsE.html>

10. TREATMENT AND DISPOSAL

10.1 **Choosing treatment and disposal methods**

The choice of treatment and disposal techniques depends on a number of parameters: the quantity and type of wastes produced, whether or not there is a waste treatment site near the hospital, the cultural acceptance of treatment methods, the availability of reliable means of transport, whether there is enough space around the hospital, the availability of financial, material and human resources, the availability of a regular supply of electricity, whether or not there is national legislation on the subject, the climate, groundwater level, etc.

The method must be selected with a view to minimizing negative impacts on health and the environment. **There is no universal solution for waste treatment.** The option chosen can only be a compromise that depends on local circumstances.

Where there is no appropriate treatment infrastructure in the vicinity, it is the responsibility of the hospital to treat or pre-treat its wastes **on-site**. This also has the advantage of avoiding the complications involved in the transport of hazardous substances (see previous chapter).

The following treatment or disposal techniques may be used for hazardous medical waste, depending on the circumstances and the type of waste concerned:

→ disinfection:

- chemical: addition of disinfectants (chlorine dioxide, sodium hypochlorite, peracetic acid, ozone, alkaline hydrolysis);
- thermal
 - low temperatures (100° to 180°C): vapour (autoclave, micro-waves) or hot air (convection, combustion, infrared heat);
 - high temperatures (200° to over 1000°C): incineration (combustion, pyrolysis and/or gasification);
- by irradiation: UV rays, electron beams;
- biological: enzymes;

→ mechanical processes: shredding (a process which does not decontaminate the waste);

→ encapsulation (or solidification) of sharps;

→ burial: sanitary landfills, trenches, pits.

The techniques most likely to be used in ICRC operations are described in the present chapter along with their advantages and disadvantages.¹⁵

The appropriate treatment and disposal techniques for the various types of waste are set out in Table 10.1 (and in the data sheets in Annex 1).

¹⁵ See the following publication for further details on techniques other than incineration (suppliers, prices, technologies): Health Care Without Harm, *Non-Incineration Medical Waste Treatment Technologies*. http://www.noharm.org/lib/downloads/waste/Non-Incineration_Technologies.pdf

Table 10.1 Suitability of treatment techniques by type of waste

| Type of waste / Technique | 1. Sharps | 2a. Waste entailing risk of contamination | 2b. Anatomical waste | 2c. Infectious waste | 3a. Medicinal waste | 3d. Chemical waste |
|--|---|---|----------------------|---------------------------|----------------------|----------------------|
| Rotary kiln 900-1200°C | yes | yes | yes | yes | yes | yes |
| Pyrolytic or dual-chamber incinerator >800°C | yes | yes | yes | yes | no | no |
| Single-chamber incinerator 300°-400°C | yes with precautions | yes with precautions | yes with precautions | yes with precautions | no | no |
| Chemical disinfection | yes | yes | no | yes | no | no |
| Autoclave | yes | yes | no | yes | no | no |
| Encapsulation | yes | no | no | no | yes | yes small quantities |
| On-site burial pit | yes | yes | yes | yes after decontamination | yes small quantities | no |
| Needle pit | yes | no | no | no | yes small quantities | no |
| Off/site sanitary landfills | yes small quantities, using encapsulation | yes with precautions | no | yes after decontamination | no | no |

Figure 10.1 is an example of a diagram intended to support decision-making on the treatment methods to be used in the absence of appropriate regional infrastructures.

Figure 10.1 **Example of a diagram intended as a guide for deciding on the treatment/disposal methods to be used in the absence of appropriate regional infrastructures**

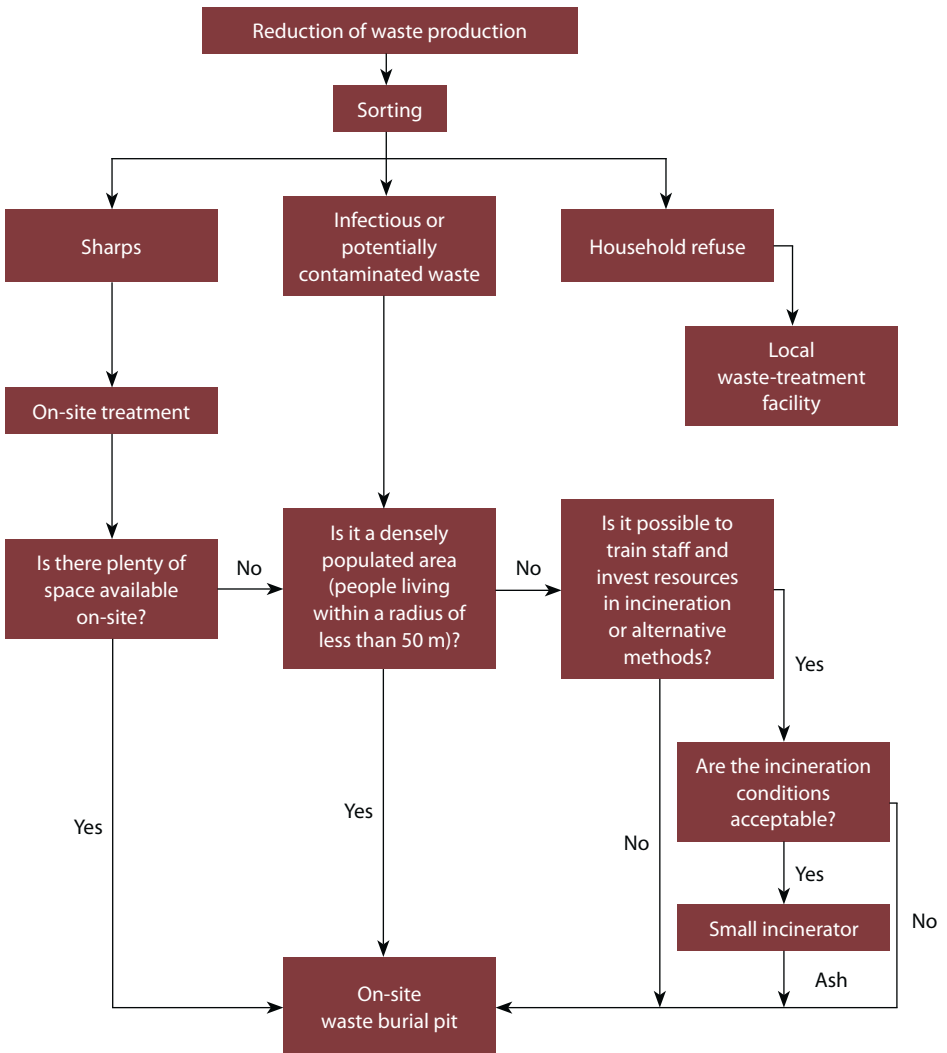

10.2 **Incineration**

Controlled incineration at high temperatures (over 1000°C) is one of the few technologies with which all types of health-care waste can be treated properly and it has the advantage of significantly reducing the volume and weight of the wastes treated.

However, modern large-scale processing plants such as high-temperature incinerators are not a solution for hospitals; they are designed for centralized networks. Enquiries should be made as to whether there is an infrastructure of this nature in the region. Another possibility is to use a household refuse incineration plant. This type of plant generally operates at over 850°C. But medical waste must be fed directly into the kiln hopper, thus bypassing the bunker. Cement works incinerators or the blast furnaces used in the metal industry can also provide an acceptable local solution, although not normally recommended for the incineration of medical waste (because the waste loading system is not secured and the emissions are not treated).

There are simple incinerator models for treating small quantities of medical waste. Some are available on the market, and others have to be built with local materials on the spot according to relatively simple plans. These incinerators consist essentially of one or two combustion chambers (the primary and secondary chambers) and a discharge chimney. The combustion and air-borne emission control system is simple; indeed, in some cases there is none.

Links for the technical specifications for small incinerators:

- Publication prepared with the assistance of the WHO, Africa Region, *Managing Health Care Waste Disposal* (WDU): http://www.healthcarewaste.org/documents/WDU_guidelines2_en.pdf
- See http://www.mw-incinerator.info/en/101_welcome.html, for further information on the construction of De Montfort incinerators.

There are two De Montfort models – to be constructed with local materials – that can be considered for ICRC hospitals: the De Montfort 8a (12 kg/h, for hospitals with less than 300 beds) or the De Montfort 7 (for emergencies). These small incinerators are composed of two combustion chambers. They cost Sfr 1,000 and can be built in three or four days. The manufacturer indicates a temperature of 800°C in the secondary chamber. The principle of the De Montfort incinerators is illustrated in Figure 10.2.

Figure 10.2: The principle of De Montfort incinerators (Pr. D.J. Picken)

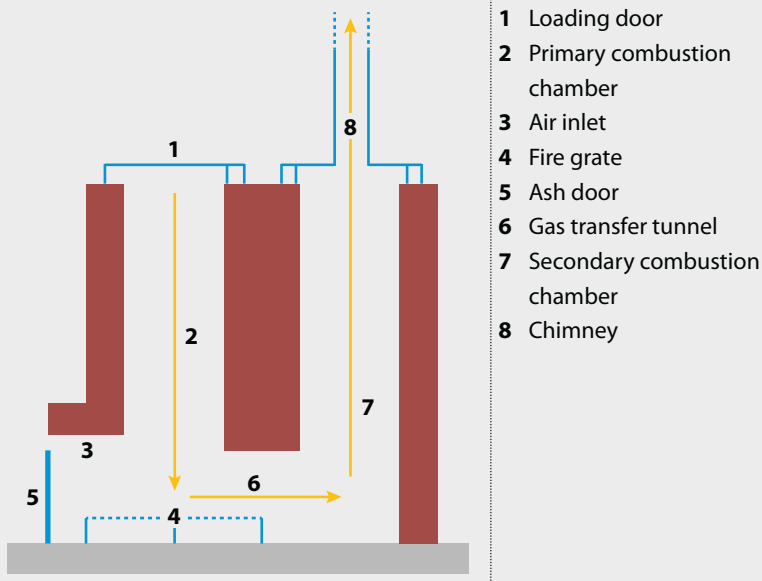

- 1 Loading door
- 2 Primary combustion chamber
- 3 Air inlet
- 4 Fire grate
- 5 Ash door
- 6 Gas transfer tunnel
- 7 Secondary combustion chamber
- 8 Chimney

Incinerators can also be imported and assembled on the spot without the use of local materials. These facilities are generally more reliable, provided that there is a reliable source of electricity. They guarantee combustion temperatures of over 800°C and even over 1000°C. However, they are also more expensive and require more maintenance.

If infectious medical waste is treated in small single-chamber or dual-chamber incinerators on site, fractions of waste such as drugs, chemicals, halogenated materials or wastes with high heavy metal content (such as batteries, broken thermometers, etc.) must not be treated in this type of facility. The following best practices must be borne in mind with a view to minimizing pollutant emissions:¹⁶

- reduction of waste generated and sorting of wastes at the source.
- good incinerator design to ensure optimal combustion conditions: extension of the chimney (if the height of the chimney is doubled from 3 to 6 metres, the concentrations of pollutants in the air are 5 to 13 times lower).¹⁷
- installation of incinerators far from inhabited or cultivated areas;
- best operating practices: appropriate startup and cooling, care to obtain a sufficiently high temperature before feeding the wastes in, adherence to the correct quantity of waste and fuel, regular removal of ash;

16 Secretariat of the Basel Convention, *Technical Guidelines on the Environmentally Sound Management of Biomedical and Health-Care Waste (Y1, Y3)*, 2003; <http://www.basel.int/pub/techguid/biomed-e.pdf>

Secretariat of the Stockholm Convention, UNEP: *Guidelines on best available techniques and provisional guidance on best environmental practices*, 2007 http://chm.pops.int/Portals/0/Repository/batbep_guideline08/UNEP-POPS-BATBEP-GUIDE-08-18.English.PDF

17 S. Batterman, *Findings on an Assessment of Small-scale Incinerators for Health-care Waste*, WHO, 2004; http://www.who.int/water_sanitation_health/medicalwaste/en/smincineratorstoc.pdf

- the incinerator should be lit with paper, wood or fuel oil; after 30 minutes, small quantities of waste should be loaded at regular intervals (5-10 minutes); wet waste must be mixed with drier waste; sharps containers must be loaded one by one; the incinerator must run for long periods (at least 2 hours); heavy-duty gloves, a body protection, and goggles must always be worn as well as a respirator whenever ash is being removed;
- no incineration of PVC plastics or other wastes containing chlorine;
- regular planned maintenance: replacement of faulty parts, inspection, inventory of spare parts;
- regular training for operators, operating manual;
- emission control: emissions must not exceed the national limit values and they must comply with the BAT/BEP¹⁸ recommendations set forth in the Stockholm Convention.

And lastly, the burning of hazardous medical waste (uncontrolled incineration in barrels or at dumps) must be avoided at all times because of the risk for staff, which is due not only to the emission of toxic gases but also to the fact that infectious wastes are not fully burnt. In an emergency, however, incineration in a barrel can be a temporary solution until a better solution is found. In this case, care must be taken to use a barrel with sufficient air intake below the combustion flame and to protect the top with fine wire mesh (to contain the ash). It should be noted that Annex C of the Stockholm Convention rejects techniques of uncontrolled incineration in barrels, at dumping sites or in single-chamber incinerators. These techniques must be regarded as provisional arrangements.

18 Best Available Technique / Best Environmental Practice

Table 10.2 **Advantages and drawbacks of incineration**

| Incineration | Advantages | Drawbacks |
|--|---|---|
| High-temperature incinerator (> 1000°C) Rotary kiln (> 1200°C) | <ul style="list-style-type: none"> → The waste is completely destroyed. → The waste is not recognizable. → Waste volume and weight are significantly reduced. → Large quantities of waste can be treated. → Toxic emissions are reduced. → Suitable for all types of waste. | <ul style="list-style-type: none"> → High construction costs (Sfr. 25,000 to 100,000 – Sfr 350,000 in the case of rotary kilns). → Relatively high operating and maintenance costs; the more sophisticated the emission control system, the higher the costs. → Requires electricity, highly skilled staff, and fuel. → Produces ash that contains leached metals, dioxins and furans. |
| Dual-chamber incinerator (800° - 900°C) Household refuse incineration plant | <ul style="list-style-type: none"> → Micro-organisms are completely destroyed. → Waste volume and weight are significantly reduced (>95%). → All types of organic waste (liquid and solid) are destroyed. → Large quantities of waste can be treated. | <ul style="list-style-type: none"> → Relatively high investment costs (Sfr 15,000) → Needs fuel. → Requires skilled staff and permanent monitoring. → Emission of toxic flue gas (including dioxins and furans). → Sharps are not destroyed. → Unsuitable for chemical and pharmaceutical wastes. → Produces ash that contains leached metals, dioxins and furans. |

| | | |
|---|--|---|
| <p>Single-chamber incinerator (300°-400°C)</p> | <ul style="list-style-type: none"> → Relatively effective disinfection. → Waste volume and weight are significantly reduced. → Simple and cheap (Sfr 1000). | <ul style="list-style-type: none"> → Needs fuel. → Wastes are only partially burnt – risk of incomplete sterilization. → Significant levels of emission of atmospheric pollutants. → Soot needs to be removed periodically. → Ineffective for destroying heat-resistant chemicals or pharmaceuticals. → Sharps are not destroyed. → Produces ash that contains leached metals, dioxins and furans. |
|---|--|---|

10.3 **Chemical disinfection**

Chemical disinfection, which is commonly used in health facilities to kill micro-organisms on medical equipment, has been extended to the treatment of health-care wastes. Chemicals are added to the wastes to kill or inhibit pathogens. However, the chemicals that are used themselves entail a health risk for the people who handle them and a risk of environmental pollution.

This type of treatment is suitable mainly for treating liquid infectious wastes such as blood, urine, faeces or hospital sewage. Typically, a 1% bleach (sodium hypochlorite) solution or a diluted active chlorine solution (0.5%) is used. In the case of liquids with high protein content, such as blood, a non-diluted solution of bleach is required as well as a contact time of more than 12 hours. Pay caution that when bleach is mixed with urine, toxic gases are formed (combination of chlorine and ammonia). Furthermore, liquid waste that has been disinfected with chlorine must not be discharged into a septic tank.

The other disinfectants used are as follows: lime, ozone, ammonium salts and peracetic acid. Formaldehyde, glutaraldehyde and ethylene oxide must no longer be used because of their toxicity (carcinogenic or sensitizing properties). All strong disinfectants irritate the skin, eyes and respiratory system. They must be handled with caution – in particular, personal protective equipment must be used – and they must be stored correctly.

Solid medical waste can be chemically disinfected, but they must first be shredded. This practice poses a number of safety problems, and the wastes are only disinfected on the surface. Thermal disinfection must be preferred over chemical disinfection for reasons of effectiveness and for ecological reasons.

Table 10.3: **Advantages and drawbacks of chemical disinfection**

| Advantages | Drawbacks |
|---|--|
| <ul style="list-style-type: none"> → Simple. → Relatively cheap. → Disinfectants are widely available. | <ul style="list-style-type: none"> → The chemicals used are themselves dangerous substances, which must be handled with caution. → For proper disinfection, the prescribed contact time and concentrations must be complied with. → The waste volume is not reduced. → The wastes have to be shredded /mixed before being treated with chemicals. → The final disposal method must be the same as for untreated medical waste. → The process generates dangerous effluents, which need to be treated. → Mixing chlorine/hypochlorite with organic matter or ammonia creates toxic substances. |

10.4 **Autoclaving**

Autoclaving is a thermal process at low temperatures where waste is subjected to pressurized saturated steam for a sufficient length of time to be disinfected (60 minutes at 121°C and 1 bar). Where prions (which cause Creutzfeldt-Jakob's disease) are present, a cycle of 60 minutes at 134°C is recommended, since they are exceptionally resistant.¹⁹ Efficiency tests (biological or thermal) must in any case be carried out regularly.

Autoclaving is environmentally safe but in most cases it requires electricity, which is why in some regions it is not always suitable for treating wastes.

¹⁹ Recommended by the Robert Koch Institute (Germany)

Small autoclaves are frequently used for sterilizing medical equipment, but the models used for treating health-care wastes can involve relatively complex and expensive plants (with internal mixing, shredding and drying systems) requiring meticulous design, proper sorting and a high level of operating support and maintenance. Furthermore, the effluents must be disposed of carefully and properly monitored. And lastly, large autoclaves may require a boiler that generates several types of emissions, which have to be monitored.

Once wastes have been processed in an autoclave, they are no longer infectious materials: they can be landfilled with municipal refuse. Autoclaving is often used for pre-treating highly infectious waste before it is transported outside the hospital.

Table 10.4: **Advantages and drawbacks of steam disinfection**

| Advantages | Drawbacks |
|--|--|
| <ul style="list-style-type: none"> → Autoclaved waste becomes safe household refuse. → Health facilities are familiar with this processing method. → Ecologically sound technology. → Facilitates the recycling of plastics. → Low operating costs. | <ul style="list-style-type: none"> → Moderate to high installation costs (Sfr 500 to 100,000). → Requires electricity. → Produces contaminated effluents, which need to undergo special treatment. → In some cases a boiler is needed with emission control. → Unsuitable for chemical or pharmaceutical wastes. → The appearance of the waste does not change. → Shredding is essential in order to avoid re-use. → The weight of the waste does not change. → Unpleasant odours. → Presence of chemicals which can generate toxic fumes. → Slow and time-consuming. |

10.5 Needle extraction or destruction

For safety reasons, the ICRC does not recommend that needles be extracted or destroyed, although this practice is followed in certain circumstances, mainly for two reasons: when the needles are removed from used syringes they cannot be re-used, and, secondly, the volume of sharps is reduced.

Some appliances run on electricity (destroying the needles by melting) and cannot be used widely in ICRC contexts, particularly in remote areas. Furthermore, these appliances require regular maintenance and have to be handled with care.

Needles can also be removed from syringes immediately after the injection by means of small manually operated

devices. The needles are then discarded into the sharps pit. Plastic syringes must be disinfected before being disposed of in the household refuse chain or in plastics recycling.

Further information on needle extractors can be obtained from the Program for Appropriate Technology in Health (PATH)²⁰ or on the WHO website.²¹

Table 10.5 **Advantages and drawbacks of needle extractors and destroyers**

| | Advantages | Drawbacks |
|-------------------------|---|---|
| Needle extractor | <ul style="list-style-type: none"> → Prevents re-use of syringes and needles. → Relatively cheap models (Sfr 2 to Sfr 80) are available that are manufactured locally. → The volume of sharps is reduced. → Plastic from syringes can be recycled after being disinfected and shredded. → Easy to use. | <ul style="list-style-type: none"> → Risk of splashing body fluids. → Some models run on electricity. → The needles and syringes remain contaminated. → Risk of breakdown of destroyer. → The needles are prone to come out of the receptacle. → The safety of the process has not been established. |
| Needle destroyer | <ul style="list-style-type: none"> → Destroys the needles completely. → Plastic from syringes can be recycled after being disinfected and shredded. | <ul style="list-style-type: none"> → Cost (Sfr 100 to Sfr 600). There should be one in each room or ward. → Requires electricity. → A sterile part of the needle remains attached to the syringe. |

²⁰ <http://www.path.org/publications/browse.php?k=10>

²¹ <http://www.healthcarewaste.org>

10.6 Shredders

Shredders cut the waste into small pieces. This technique requires competent staff for operating and maintaining the device, since some of these rotary devices are industrial models. They are often built into closed chemical or thermal disinfection systems. However, grain mills can be converted into simple shredders, but due to the risk for staff while the shredder is running only disinfected waste should be treated in these devices. Shredding, which in certain circumstances provides a means of recycling plastics and needles, should be considered whenever needles and syringes are available in large quantities, this involves a centralized system for collecting and transporting wastes from the various facilities.

Table 10.6 **Advantages and drawbacks of shredders**

| Advantages | Drawbacks |
|---|--|
| <ul style="list-style-type: none"> → Makes the waste unrecognizable. → Prevents the re-use of needles and syringes. → Reduces volume. → Facilitates the recycling of plastics. → Enhances the effectiveness of chemical or thermal treatment in closed and integrated systems. | <ul style="list-style-type: none"> → Requires electricity. → Some facilities are very expensive. → The shredder can be damaged by large pieces of metal. → The waste is not disinfected. → The staff are exposed to air-borne pathogens when untreated waste is shredded. → Requires skilled staff and permanent monitoring. |

10.7 Encapsulation

Encapsulation (or solidification) consists of containing a small number of hazardous items or materials in a mass of inert material. The purpose of the treatment is to prevent humans and the environment from any risk of contact.

Encapsulation involves filling containers with waste, adding an immobilizing material, and sealing the containers. The process uses either cubic boxes made of high-density polyethylene or metallic drums, which are three-quarters filled with sharps, chemical or pharmaceutical residues, or incinerator ash. The containers or boxes are then filled up with a medium such as plastic foam, bituminous sand, lime, cement mortar, or clay. Once the medium has dried, the containers are sealed and disposed of in a sanitary landfill or waste burial pit.

The following proportions are recommended, for example: 65% pharmaceutical waste, 15% lime, 15% cement, 5% water.

The main advantage of the process is that it is very effective in reducing the risk of scavengers gaining access to the hazardous waste. Encapsulation of sharps is generally not considered to be a long-term solution. Encapsulation of sharps or unwanted vaccines could, however, be envisaged in temporary settings, such as camps or vaccination campaigns.

Table 10.7 **Advantages and drawbacks of encapsulation**

| Advantages | Drawbacks |
|--|---|
| <ul style="list-style-type: none"> → Simple, inexpensive and safe. → A solution that can be envisaged for sharps and pharmaceutical wastes. → The risks for scavengers are reduced. | <ul style="list-style-type: none"> → To be regarded as a temporary solution. → The quantities of waste treated are small. → The weight and volume of the waste is increased. |

10.8 **Disposal in a sanitary landfill or waste burial pit**

The disposal of untreated health-care waste in an uncontrolled dump is not recommended and must only be used as a last resort.

It can be disposed of in a sanitary landfill, subject to certain precautions: it is important that health-care waste be covered rapidly. One technique is to dig a trench down to the level where old municipal refuse (over three months old) has been buried and to immediately bury health-care waste that is discarded at this level under a 2-metre layer of fresh municipal refuse.

The following are the essential factors that must be taken into consideration in the design and use of a sanitary landfill:²²

- access must be restricted and controlled;
- competent staff must be available;
- the discarding areas must be planned;
- the bottom of the landfill must be waterproofed;
- the water table must be more than 2 metres below the bottom of the landfill;
- there must be no drinking water sources or wells in the vicinity of the site;
- chemicals must not be disposed of on these sites;
- the waste must be covered daily and vectors (insects, rodents, etc.) must be controlled;
- the landfill must be equipped with a final cover to prevent rainwater infiltration;
- leachates must be collected and treated.

Whenever a municipal landfill is being used, the water and habitat engineer must inspect the site before hazardous medical waste are discarded there.

22 Further information on the design of sanitary landfills can be found in *Solid Waste Landfills in Middle- and Lower- Income Countries: A Technical Guide to Planning, Design, and Operation*. Rushbrook, Philip and Pugh, Michael. 1999. *World Bank Technical Paper* No. 426. The World Bank, Washington, D.C. pp. 248.

A purpose-built burial pit could also be used, preferably on the hospital site. Ideally, the pit should be lined with low-permeability material such as clay to prevent the pollution of shallow groundwater and should be fenced in so as to prevent scavenger access. Health-care wastes must be buried immediately under a layer of soil after each unloading operation. It is suggested that lime be spread on the waste for added health protection (in the event of an epidemic, for example) or to eliminate odour. The pit should be sealed once it has been filled.

Examples of burial pits or wells for anatomical waste or sharps are presented in Annex 2 (data sheets 13, 14 and 15).

Table 10.8 **Advantages and drawbacks of disposal by burial**

| | Advantages | Drawbacks |
|---|---|--|
| Sanitary landfill, trench method | <ul style="list-style-type: none"> → Simple and inexpensive operating costs. → Can be carried out using an existing municipal waste management system. → Scavengers cannot access the health-care waste if the landfill is well managed. | <ul style="list-style-type: none"> → The health-care wastes are not treated and remain hazardous. → The landfill must be secure, fenced in, and guarded. → Scavengers and animals need to be controlled. → A high degree of coordination is needed between collectors and landfill operators. → Makes health workers less aware of the need to sort the various types of waste. → Transport to the landfill can be a lengthy and costly operation. → Risk of water pollution. |
| Separate pit on hospital site | <ul style="list-style-type: none"> → Simple and relatively inexpensive to build and manage. → Dangerous substances are not transported outside the hospital. → Control is facilitated. | <ul style="list-style-type: none"> → The health-care waste is not treated and remains hazardous. → Risk of water pollution. → Problem of odour. → Vectors (insects, rodents, etc.) need to be controlled. → Space is needed around the hospital. |

10.9 Disposal of liquid wastes in the sewage

In general, the sewage system should not be used to dispose of chemicals. It is strictly prohibited to dilute wastewater discharges so that the concentration falls below the exemption thresholds in force in the particular country. Scientific or legislative data on exemption thresholds are rare. The exemption thresholds in effect in Switzerland are set out in Table 10.9.

Table 10.9 **Permissible limits in force in Switzerland
(Decree on water protection, Switzerland)**

| Chemicals | Permissible limits | Practical disposal |
|--|---------------------|--|
| Acids – alkalis | pH between 6.5 et 9 | Exceptions are allowed if the chemicals are mixed with a sufficient quantity of other sewer effluents. |
| Silver | 50 mg/l | If less than 1000 litres are produced per year. |
| Total hydrocarbons Organic solvents | 20 mg/l | Tolerance allowed for products which biodegrade easily and which are disposed of in small quantities, provided there is no noteworthy effect on health or the environment. |
| Volatile halogenated hydrocarbons Volatile halogenated solvents | 0,1 mg/l Chlorine | No tolerance. |

Photographic developing liquids should, as a rule, not be poured down the drain, since they contain substances that are toxic or even carcinogenic (silver, hydroquinone, formaldehyde). If it is not possible to have them recycled by an approved firm, small quantities may, as an exception, be discharged within the limits set out above. Fixers and developers must be mixed and stored for one day (neutralization

process) and then diluted (1:2) and emptied slowly into the sink.

Non-hazardous pharmaceutical wastes (syrups, vitamins, eye drops, etc.) may be poured down the drain, **unless otherwise stated by national legislation.**

Liquid biological waste (small quantities of blood, rinsing liquids from operating theatres, etc.) may be poured down the drain without being pre-treated, unless the patient is suffering from an infectious disease. In all other cases it must first be inactivated – preferably by autoclave, but otherwise by means of a chemical disinfectant (undiluted bleach or chlorine dioxide, contact time of more than 12 hours).

Where a septic tank is used, the quantity of disinfectant or biocide (bleach, silver, etc.) should be reduced, since these substances can actually disrupt the biological digestion of the wastes.

Expired units of blood must not be emptied down the drain. They must be incinerated at high temperature (over 1000°C) or autoclaved. Where there are no such facilities, they must be disposed of in a waste burial pit.

At all times, any national regulations that are more stringent than the general recommendations set out above must be complied with.

11. STAFF PROTECTION MEASURES

The handling of waste entails health risks for staff throughout the chain. The purpose of protective measures is to reduce the risks of accident/exposure or the consequences. Preventive measures can be divided into two categories: primary and secondary. Primary prevention comprises four levels of action:

Primary prevention:

- Eliminating hazard: for example, by using less toxic substances, eliminating mercury, or using self-locking injection equipment.
- Collective and technical prevention: for example, using needle receptacles, ventilation.
- Organizational prevention: such as assigning duties and responsibilities to all involved, management (sorting, packaging, labelling, storage, transport), best practices (such as refraining from putting the caps back on syringes), training.
- Individual prevention: personal protective equipment, vaccination, washing hands.

Secondary prevention:

Measures in the event of an accident (accidental exposure to blood, spills).

The local waste manager, hospital administrator and head nurse will be responsible for checking regularly to see whether the protective measures are being complied with. The water and habitat engineer must analyse risks on a regular basis in order to monitor the effectiveness of the measures taken and to identify any additional steps to be taken.

Protective measures depend on the risk concerned. In addition to the risk of infection, the other risks must be borne in mind: chemical risks, mechanical risks involved with machinery/plants, risk of burns (incinerators, autoclaves), risks associated with physical load or the absence of ergonomic principles (when drums that are unsuitable for containing wastes are being shifted, for example), risk of falling when working in wet areas, etc.

11.1 **Personal protective equipment**

The choice of protective equipment, such as gloves, will depend on the activity involved (waste staff will not wear the same type of gloves as care staff).

The following personal protective equipment is generally available:

Table 11.1 **Personal protective equipment (PPE)**

| | |
|---|--|
| <p>Face protection - visor Eye protection – safety goggles</p> | <p>To be worn during all activities where body fluids or chemicals are liable to be splashed, and for work at an incinerator.</p> |
| <p>Respiratory protection – masks and respirators</p> | <p>FFP1 dust respirators²³ for staff involved in any activity that generates dust (removing ash, sweeping out the waste storage facility). FFP2 respirators²⁴ for staff involved in handling waste from patients suffering, for example, from tuberculosis. N.B.: → FFP1-FFP2-FFP3 dust respirators do not provide protection from gas and fumes (such as mercury or solvent fumes); → surgical masks protect the patient; they provide only limited protection for staff (see Photos 11.1 and 11.2).</p> |
| <p>Body protection – aprons, protective suits</p> | <p>For staff involved in collecting, transporting and treating wastes.</p> |
| <p>Hand protection – gloves</p> | <p>Disposable gloves for care staff or cleaning staff (vinyl or nitrile). Disposable gloves for laboratory staff (nitrile). Heavy-duty protective gloves for staff involved in transporting and treating wastes. N.B.: → latex gloves are to be avoided (can cause allergy); → nitrile is more chemical-resistant and tear-resistant than vinyl.</p> |
| <p>Foot and leg protection – boots, shoes</p> | <p>Closed, non-slip shoes for all staff. Puncture-proof safety shoes or boots.</p> |

²³ Standard EN149: 2001 and European Directive 89/686/EEC on personal protective equipment (PPE).

²⁴ See the following publications for further details: GERES, *Manuel pratique: prévention et prise en charge des AES, 2008*, or WHO/ ILO, *Post-exposure prophylaxis to prevent HIV infection*, 2007. http://whqlibdoc.who.int/publications/2007/9789241596374_eng.pdf



Photo 11.1:
Surgical mask

- Protects against aerosols exhaled by the wearer
- Effectiveness rated for exhalation



Photo 11.2:
FFP1, FFP2 or FFP3 respirator

- Protects the wearer against the risk of inhaling particles (dust)

11.2 **Personal hygiene**

Elementary personal hygiene is important for reducing risks of infections and breaking the infection chain when medical waste are being handled.

Washing one's hands meticulously with a sufficient amount of water and soap eliminates over 90% of the micro-organisms present.

Ideally, wash basins with hot water and soap should be installed wherever wastes are handled (storage and treatment areas).

When should one wash one's hands?

- when going on and off duty;
- after any contact with wastes;
- after removing gloves;
- after removing a mask or respirator;
- before/after certain routine actions (eating, using the toilet, blowing one's nose);

How should one wash one's hands? (Norm NF EN 1500)

- wet the hands and wrists;
- apply a dose of liquid soap;
- lather the soap by rubbing the hands, paying particular attention to the parts between the fingers and around the nails and to the thumbs (40-60 seconds);
- rinse;
- dab dry;
- do not use a brush (which promotes the penetration of micro-organisms).

11.3 Vaccination

The hepatitis B virus disease can be avoided by vaccination, which has been available since 1980. Numerous studies have shown that the vaccine is effective in preventing all of the forms of infection with hepatitis B virus. Although this vaccination is safe, effective and cost-efficient, it is still under-used.

Staff handling wastes must be appropriately protected by vaccination, including vaccination against hepatitis A and B and tetanus.

11.4 Measures to be taken in the event of accidental exposure to blood²⁵

50% of accidental exposures to blood (AEB) are avoidable. The objective of an AEB prevention policy is to reduce the risk of accident for staff handling body fluids and wastes, but also to reduce the risk of contamination whenever an accident occurs.

²⁵ See the following publications for further details: GERES, *Manuel pratique : prévention et prise en charge des AES*, 2008, or WHO/ILO, *Post-exposure prophylaxis to prevent HIV infection*, 2007. http://whqlibdoc.who.int/publications/2007/9789241596374_eng.pdf.

The risk of the infection being transmitted after a needle-prick injury is presented in Table 11.2.

Table 11.2 **Risk of transmission of infection after percutaneous exposure to contaminated blood**

| Virus | Risk of transmission of infection |
|-------------------|-----------------------------------|
| HIV | 0,3 % |
| Hepatitis B Virus | 5-30 % |
| Hepatitis C Virus | 1-3 % |

AEB management should comprise the following:

- the measures to be taken in the event of an accident must be displayed on a poster (a sample poster is shown in Annex 3.6):
 - wash the contaminated area with soap and water; do not make the area bleed; disinfect the area (freshly diluted bleach (0.5%), active chlorine or Betadine® or 70° alcohol or stabilized Dakin's solution, contact time of more than 5 minutes);
 - telephone number at which competent help is available at all times.
- a competent person must take charge of the situation (evaluation, tests, post-exposure prophylaxis [HIV, tuberculosis, hepatitis B], follow-up, information, psychological care for the victim);
- registration of incidents/accidents, investigation and corrective action.

Post-exposure prophylaxis reduces the risk of developing the HIV disease by 80%.

11.5 **Emergency measures in the event of spills or contamination of surfaces**

Most accidents involving the spilling of chemicals or infectious material occur in laboratories. But accidents can also involve mercury waste (breaking a thermometer, blood pressure gauge or glass receptacle containing mercury) or they can occur during the transport of chemical wastes (knocking over poorly closed cans, breaking glass bottles), or if bags containing infectious wastes tear.

Spills of infectious biological material on a mattress or on the floor

- Change gowns and clothes that are visibly soiled immediately.
- Warn the other colleagues present and protect the contaminated area.
- Wear disposable gloves and, if aerosols are present, goggles and a respirator for protection from particles (FFP1 or FFP2).
- Cover the contaminated area with absorbent paper soaked with disinfectant.
- Cover the contaminated area with a disinfectant, working in concentric circles from the edges towards the centre. Avoid spraying the disinfectant or pouring it from a height, since this can produce aerosols.
- Let the disinfectant take effect, depending on its properties (generally at least 3 minutes).
- Sponge the area, and dispose of all of the wastes and soiled material in the appropriate container (infectious wastes). Be very careful with fragments of sharps, which must be picked up with tweezers and placed in the sharps container.
- Disinfect all of the items on the mattress, the surface of furniture or equipment that might have been contaminated.
- Remove personal protective equipment, dispose of the contaminated material in the infectious waste bin and autoclave it (or, if there is no autoclave, incinerate it).

- Disinfect your hands.
- Register the accident.

Chemical spill procedure

- Warn people in the immediate area.
- Put on gown, gloves and protective goggles.
- Avoid breathing fumes.
- If the spilled substances are flammable, switch off all sources of ignition and heat.
- Open the windows and air the area; close the doors of the affected rooms.
- Cover the spill with absorbent material (absorbent cloth or granules), working from the edges towards the centre in concentric circles.
- Mix gently with a wooden spatula until all of the spilled chemical has been completely absorbed.
- Dispose of the granules or cloth as special waste.
- Clean the soiled area thoroughly with water (unless the chemical concerned is incompatible with water!).

Mercury spill procedure

- Mark out the area to be decontaminated and prohibit access.
- It is essential to gather up all of the mercury that has been spilled (also check under instruments, in cracks, etc.) without dispersing it. Wear disposable (single-use) gloves. Use a mercury sponge, a glass or plastic pipette, or two sheets of paper to pick up the mercury beads (do not use a brush or broom or a vacuum cleaner).
- Put the mercury and the gathering equipment in a leak-proof container. Close the container tightly and label it as special mercury waste and take it to the pharmacy.
- Shine a beam of light on the area (using a flashlight, for example) to check that all the mercury beads have been collected.

11.6 **Emergency measures in the event that persons have been contaminated**

Splashing of chemicals onto the skin and eyes

- Rinse the exposed areas thoroughly with water for 15 minutes, without rubbing. Do not use a neutralizing agent or any other product (detergent, cream, etc.).
- If the chemical has gone into the eye, rinse the eye with running water for 10-30 minutes (opening the eyelids wide, holding head tilted to one side with the affected eye lower down). Consult an ophthalmologist urgently.
- Using gloves, remove contaminated clothing with care (in the case of chemical burns).
- Seek medical attention urgently.

Procedure in the event of chemical ingestion

- Rinse out the mouth thoroughly with water.
- Do not induce vomiting or give the person anything to drink.
- Seek medical attention urgently.

Procedure in the event of inhalation of toxic gases

- Leave the contaminated area immediately.
- Seek medical attention urgently, even if there are no symptoms.

12. TRAINING

12.1 Why and how

The purpose of training is to develop skills on the one hand and to raise awareness on the other. It is important to highlight the role(s) to be played by each individual staff member.

In order to facilitate communication amongst the various actors, it is recommended that training be targeted at a multidisciplinary group and provided at the workplace so as to promote best practices and teamwork. However, it is recommended that groups should not exceed 20 participants.

Refresher courses should be held regularly as well as courses to inform staff of any changes that have taken place in the waste management plan and, of course, training courses for new members of staff.

The training can be provided by the water and habitat engineer, the hospital administrator or an external body.

Some examples of training in waste management:

- The WHO published a training manual entitled *Teachers' guide: management of wastes from health-care activities*²⁶ in 1998. This training material, which contains recommendations, is intended for a 3-day training course targeting mainly hospital administrators, public health professionals and policy makers. The WHO also proposes a basic 3-day training course for waste managers in care facilities.²⁷
- The Indira Gandhi National Open University, New Delhi, offers a distance-learning course in collaboration with the WHO. This is a 6-month course leading to a health-care waste management certificate.

Irrespective of the methods used, it is important that the staff be trained so that the procedures for managing waste are complied with throughout the waste management chain.

²⁶ http://www.who.int/water_sanitation_health/medicalwaste/wsh9806/en/

²⁷ This course has been designed by the WHO Communicable Diseases Unit, Regional Office for Europe: www.euro.who.int

It is recommended that ICRC hospitals prepare training material specific to each context.

12.2 **Content**

This training must focus on presenting a waste management plan, the risk associated with wastes, protective measures, the role and responsibilities of each member of staff, and the technical instructions concerning the activities carried out by each category of staff.

Additional training for care staff

Emphasis must be laid on sorting, sharps management and AEB management.

Additional training for staff handling waste

Emphasis must be laid on sorting, collection and transport procedures, cleaning and personal hygiene, PPE, protective measures when handling bags (see Chapter 7.3) and measures in the event of an accident.

Additional training for staff in charge of waste treatment plants or sanitary landfills

In addition to the general modules described above, the following subjects must be covered: plant operation, maintenance, environmental impact.

Additional training for management and administrative staff

Emphasis must be laid on national legislations and international conventions, responsibilities, and purchasing/minimization policy.

13. FURTHER INFORMATION

A. Prüss, E. Giroult, and P. Rushbrook, *Safe management of wastes from health-care activities*, WHO, 2010.

WHO sites (on the subject of health-care wastes):

http://www.who.int/topics/medical_waste/fr/index.html

<http://www.healthcarewaste.org>

Non-Incineration Medical Waste Treatment Technologies, Health Care Without Harm, 2001.

Health Care Without Harm site:

<http://www.noharm.org>

GERES/ESTHER, *Prévention et prise en charge des AES, manuel pratique*, 2008.

PATH publications (needle removers and destroyers):

<http://www.path.org/publications/browse.php?k=10>

ISWA technical policy No. 11: Healthcare Waste, ISWA, 2007.

O. Aki Kleiner, *Healthcare waste management assessment in three Afghani hospitals*, ICRC, 2003.

S. Praplan, *Hospital waste management in Lopiding surgical hospital, Lokichokio, Kenya, Evaluation report*, ICRC, 2001.

ANNEX 1

WASTE DATA

SHEETS

DATA SHEET NO. 1: SHARPS (CATEGORY 1)

DATA SHEET NO. 2: WASTE ENTAILING RISK OF CONTAMINATION (CATEGORY 2.A)

DATA SHEET NO. 3: ANATOMICAL WASTE (CATEGORY 2.B)

DATA SHEET NO. 4: INFECTIOUS WASTE (CATEGORY 2.C)

DATA SHEET NO. 5: PHARMACEUTICAL WASTE (CATEGORY 3.A)

DATA SHEET NO. 6: CYTOTOXIC WASTE (CATEGORY 3.B)

DATA SHEET NO. 7: MERCURY WASTE (CATEGORY 3.C)

DATA SHEET NO. 8: PHOTOGRAPHIC DEVELOPMENT LIQUIDS (CATEGORY 3.D)

DATA SHEET NO. 9: CHEMICAL WASTE (CATEGORY 3.D)

DATA SHEET NO. 10: PRESSURIZED CONTAINERS (CATEGORY 4)

DATA SHEET NO. 11: RADIOACTIVE WASTE (CATEGORY 5)



DATA SHEET 1

SHARPS (CATEGORY 1)

BRIEF DESCRIPTION:

Wastes entailing risk of injury.

EXAMPLES:

needles, mandrils, haematocrit tubes, pipettes, scalpel blades, lancets, trocars, microscope slides, butterfly needles, ampoules, glass vials and bottles, etc.).

RISKS:



Wastes entailing risk of injury are considered to be highly hazardous wastes.

Risk of injury and transmission of diseases (risk of accidental exposure to blood [AEB]: HIV, hepatitis B and C, etc.).

PROTECTIVE MEASURES:



Collection and packaging:

- These wastes must be collected in puncture-proof, impermeable containers that can be closed. See Data sheet no. 12 (Annex 2) for choice of sharps container. The care staff must have a sharps container at hand whenever they are using these items. They must drop sharps into the container immediately after use, without putting the cap back on the syringe needle, without removing the syringe needle by hand and without setting the unsafe item down on any surface.
- The care staff must make sure that they seal the containers once they are two-thirds full before they are removed to the interim storage area.

Storage and transport:

- Sharps containers must be stored in a separate storage facility to which only specialized staff have access.
- The containers must not be emptied or re-used or compressed to reduce the volume.

Treatment and final disposal

1. Ideally, this type of waste must be disposed of in kilns with a temperature of over 1000°C (pyrolytic incinerators or rotary kilns), where the needles are completely destroyed. A possible alternative is to dispose of them in excess-air incinerators or improved dual-chamber spontaneous combustion incinerators (800°-900°C).
2. In the absence of the kilns described in paragraph 1 above, the wastes should be disposed of in a sharps pit or should be incinerated on-site in small single-chamber or dual-chamber incinerators. (However, the ash produced in this process still contains needles and must be buried with caution.) Failing this, the alternative mentioned in paragraph 1 can be used if available.
3. In the absence of the options mentioned in paragraph 2, the waste can be disposed of in a landfill after encapsulation.

Otherwise, and in certain circumstances: needle destroyers or extractors should be used, syringes should be shredded, plastic should be recycled, and needles should be disposed of in a sharps pit.



DATA SHEET 2

WASTE ENTAILING RISK OF CONTAMINATION (CATEGORY 2. A)

BRIEF DESCRIPTION:

Waste containing blood, secretions or excreta entailing a risk of contamination.

EXAMPLES:

urine collection bags, bags of blood, abscess drainage material, soiled dressings, OT drapes, (Receptal) suction equipment, Redon bottles, staplers, pins, rinsing solutions, lab test tubes and slides.

RISKS:



Risk of transmission of infectious diseases.

PROTECTIVE MEASURES:



Collection and packaging:

- Stands or containers equipped with yellow plastic bags or with double bags where there is a lot of liquid.
- The bags must not be piled up or emptied. They must be grasped from the top. They must not be filled more than two thirds.

Storage and transport:

- Filled yellow bags must not be left in the wards.
- The bags must be transported and stored separately from household refuse. They must be stored in a separate storage facility to which only specialized staff have access.
- This type of waste must not be compressed.

Treatment and final disposal:

1. Ideally, this type of waste must be disposed of in incinerators with a temperature of over 1000°C (pyrolytic incinerators or rotary kilns). A possible alternative is to dispose of them in excess-air incinerators or improved dual-chamber combustion incinerators (800°-900°C).
2. In the absence of the incinerators described in paragraph 1 above, the wastes should be incinerated in small single-chamber or dual-chamber incinerators or they should be disposed of in a purpose-built on-site burial pit (if there is enough room and/or the area is densely populated).
3. Where there is no special burial pit, the waste should be buried at a sanitary landfill, after taking the necessary precautions (see Chapter 10.8).
4. Liquids can be poured down the drain unless they are infectious. Otherwise, see Data sheet no. 4.



DATA SHEET 3

ANATOMICAL WASTE (CATEGORY 2.B)

BRIEF DESCRIPTION:

Body parts, tissue entailing risk of contamination.

EXAMPLES:

tissue wastes, placentas, organs that have been removed, amputated limbs, fetuses, laboratory animals.

RISKS:



Risk of transmission of infectious diseases.

These wastes entail the same hazards as those listed under 2.a (wastes entailing risk of contamination), but in many cases they have to be treated differently for ethical or cultural reasons.

PROTECTIVE MEASURES:



Collection and packaging:

- Use stands or containers equipped with yellow plastic bags or with double bags where there is a lot of liquid.
- The bags must not be piled up or emptied. They must be grasped from the top. They must not be allowed to get too full.
- For cultural reasons, it will not always be possible to collect these wastes in bags.

Storage and transport:

- Interim storage in a refrigerated facility, separate from other wastes.
- Must not be compressed.

Treatment and final disposal:

- This waste must be incinerated or disposed of in accordance with local customs. In Switzerland, placentas and human body parts are incinerated in combustion furnaces or special waste incinerators. Tissue waste is disposed of in the same treatment chain as type 2.a waste.
- In the ICRC, the most common practice for placentas is to put them into a placenta burial pit (where they decompose naturally).



DATA SHEET 4

INFECTIOUS WASTE (CATEGORY 2.C)

BRIEF DESCRIPTION:

body fluids and excreta of persons suffering from infectious diseases, such as patients in isolation wards; laboratory material that is classed as infectious.

EXAMPLES:

sputum of patients with bacillary TB; faeces in the case of typhoid fever, cholera, bacterial dysentery, and rotavirus dysentery; excreta and body fluids of patients with infections caused by group 3 and group 4 pathogens: haemorrhagic fever, corona virus-associated SARS, anthrax, plague, poliomyelitis. Cultures.

RISKS:



High risk of transmission of infectious diseases.

PROTECTIVE MEASURES:



+ Disinfect the hands.

Collection and packaging:

- Use stands or containers equipped with yellow plastic bags marked with the infectious substance symbol, or with double bags where there is a lot of liquid.
- The bags must not be piled up or emptied. They must be grasped from the top. They must not be allowed to get too full.

Storage and transport:

- Infectious wastes must be treated without delay. Minimal storage time
- The bags must be transported and stored apart from other waste. They must be stored in a separate storage facility to which only specialized staff have access.
- Must not be compressed.

Treatment and final disposal:

1. This type of waste must on no account leave the hospital before being pre-treated (incineration, autoclaving, chemical treatment) on-site.
2. Where pre-treatment is not possible, the waste must be disposed of in a purpose-built on-site burial pit (in which the waste is covered with lime). Liquids should be poured down the drain after being pre-treated (autoclaving or chemical disinfection [in the case of blood: undiluted bleach or chlorine dioxide, contact time >12h]).
3. The waste should be buried in a sanitary landfill after being pre-treated.



DATA SHEET 5 PHARMACEUTICAL WASTE (CATEGORY 3.A)

BRIEF DESCRIPTION:

Unused/unwanted drugs and receptacles which contained medicines.

EXAMPLES:

expired drugs, unused drugs, contaminated drugs, bottles and vials containing drug residues.

EXCEPTIONS:

cytotoxic waste (see data sheet no. 6).

RISKS:



Toxic risk associated mainly with illegal trading in expired drugs. Propagation of antibiotic-resistant pathogens if discharged into the sewage system.

PROTECTIVE MEASURES:



Collection and packaging:

→ The collection and packaging of this waste is managed by the hospital pharmacy.

Storage and transport:

→ Store separately in a facility where access is restricted to authorized persons.

Treatment and final disposal:

1. This waste should be returned to the supplier.
2. Where the waste cannot be returned to the supplier, it should be incinerated in a rotary kiln or special waste incinerator (over 1200°C).
3. Where methods 1 and 2 are not possible, the waste should be encapsulated in small quantities and disposed of in a landfill.
4. Non-hazardous liquids (vitamins, intravenous fluids such as salts or glucose, eye drops, etc.) can be poured down the drain.
5. Empty ampoules and vials/bottles can be disposed of along with sharps.

DATA SHEET 6

CYTOTOXIC WASTE (CATEGORY 3.B)

Cytotoxic wastes are not covered in this manual, only brief information is set out below.

Cytotoxics are substances that are mainly used for cancer chemotherapy. They have the property of killing cancer cells or curbing their growth. They are used in oncology departments, radiotherapy units, laboratories and, during certain interventions in operating theatres.

The waste consists of the equipment that is contaminated during the preparation and administration of these drugs, expired drugs and the secretions or excreta of patients undergoing cytotoxic treatment.

The potential health hazard involved with cytotoxics is due mainly to the mutagenic, carcinogenic and teratogenic properties of these substances. Furthermore, they cause skin and eye irritation. Cytotoxic waste must be considered to be highly hazardous; it must never be landfilled or burnt in low- or medium-temperature incinerators or poured down the drain.

Unused cytotoxic substances must be returned to the supplier. The waste must be placed in sealed, leak-proof receptacles. They must be incinerated at high temperature (over 1200°C). Chemical decontamination is a further option. There is a chemical decontamination method that is applicable to most of the standard cytotoxic drugs, but chemical decontamination is unsuitable for body fluids that have been contaminated with cytotoxics.

Where neither high-temperature incineration nor chemical decontamination is feasible, encapsulation and inertization can be considered as a last resort.

See following publications for further information:

WHO, *Safe management of wastes from health-care activities*, 2010.

M. Allwood, A. Stanley and P. Wright (eds), *The Cytotoxics Handbook*, fourth edition, Radcliffe Medical Press, 1993.

M. Castegnaro, *Laboratory decontamination and destruction of carcinogens in laboratory wastes: some antineoplastic agents*, International Agency for Research on Cancer (IARC), 1985.



DATA SHEET 7

MERCURY WASTE (CATEGORY 3.C)²⁸

BRIEF DESCRIPTION:

waste containing mercury.

EXAMPLES:

broken thermometers or blood pressure gauges, equipment/items used to gather up a mercury spill, fluorescent or compact fluorescent light tubes.

N.B.:

mercury must be replaced with other, less toxic, substances (mercury-free thermometers and blood pressure gauges).

RISKS:



Mercury is toxic for the nervous system and reproduction; it is also sensitizing.

PROTECTIVE MEASURES:



Gas mask with chemical filter cartridge for protection against mercury compounds (EN-141-2000)

²⁸ Secretariat of the Basel Convention/UNEP, *Technical Guidelines for the Environmentally Sound Management of Wastes Consisting of, Containing or Contaminated with Mercury*.

Collection and packaging:

In all cases, the mercury must be gathered separately (see “Emergency measures in the event of spills or contamination of surfaces” (Chapter 11.5) in a sealed, leak-proof receptacle (such as a glass receptacle).

Storage and transport:

Mercury waste must be stored separately in a cool place, which is locked.

Treatment and final disposal:

1. Mercury waste must on no account be burnt or treated by any other method or landfilled or poured down the drain. Mercury waste must be taken back to the supplier or delivered to a registered recycling firm that is authorized to receive mercury waste.
2. Where it is not possible to return the waste to the manufacturer, it must be exported (Basel Convention).



DATA SHEET 8

PHOTOGRAPHIC DEVELOPMENT LIQUIDS (CATEGORY 3.D)

BRIEF DESCRIPTION:

liquids used for photographic development (radiology).

EXAMPLES:

developer, fixer, stop bath (silver halide, hydroquinone, potassium bromide, sodium sulphite, sodium carbonate, sodium thiosulphate, acetic acid, potassium hydroxide, glutaraldehyde, etc.).

RISKS:



Contain substances which are corrosive, harmful, suspected of being carcinogenic for humans, harmful by ingestion, sensitizing, and very toxic for the environment, particularly for aquatic organisms.

PROTECTIVE MEASURES:



Collection and packaging:

Photographic liquids must be collected in leak-proof containers, which must be labelled.

Storage and transport:

- Must be stored in drip trays.
- Must not be mixed with other substances.
- The load must be secured during transport.

Treatment and final disposal:

1. These substances must be taken to a firm that recycles silver.
2. Where the above procedure is not possible, they should be disposed of in a rotary kiln or at a special waste incineration plant.
3. Where procedure 2 is not possible, they can be disposed of in small quantities in pyrolytic incinerators or by encapsulation, or they can be poured down the drain within the exemption limits (fixer baths mixed with developer baths and stored for 1 day then diluted [1: 2] and poured very slowly into the sink).
4. Where procedure 3 is not possible, the substances must be exported (Basel Convention and Annex 3.5).



DATA SHEET 9

CHEMICAL WASTES (CATEGORY 3.D)

BRIEF DESCRIPTION:

chemical wastes.

EXAMPLES:

solvents, unused laboratory acids and alkalis, expired disinfectants, engine oil, insecticides, pesticides, leftover paints.

RISKS:



Various chemical risks depending on the properties of the chemicals (see signs and labelling in Annex 4).

PROTECTIVE MEASURES:



Collection and packaging:

- Chemical wastes must be collected by a person who is aware of the risks associated with the chemicals concerned (pharmacist, head of laboratory).
- Use appropriate packaging (generally high-density polyethylene HDPE; PVC or glass for highly oxidative inorganic acids).
- Never fill containers completely (less than 90%).
- The packaging must be labelled (specifying the content).
- Chemicals must not be mixed.

Storage and transport:

- Chemical wastes must be stored according to the properties of the chemicals concerned. Beware of incompatibilities (store alkalis, acids, halogenated solvents, and non-halogenated solvents in different drip trays).
- Beware of spillage during transport: store the chemicals in appropriate leak-proof receptacles, place these in drip trays, and secure the load..

Treatment and final disposal:

1. Return chemical wastes to the supplier or treat them in a special waste treatment plant or in a rotary kiln.
2. Where the facilities mentioned in paragraph 1 above are not available, small quantities of these wastes can be disposed of in a pyrolytic incinerator (not to be used for halogenated solvents), or by encapsulation (not to be used for flammable or corrosive disinfectants). These wastes can be poured down the drain if the quantities are within the exemption limits.
3. Where the possibilities mentioned in paragraph 2 above are not available, the waste should be exported (Basel Convention).



DATA SHEET 10 PRESSURIZED CONTAINERS (CATEGORY 4)

BRIEF DESCRIPTION:

pressurized cylinders.

EXAMPLES:

medical gas cylinders, combustible gas cylinders,
pesticide spray cans, deodorants.

RISKS:



- Risk of explosion by shock or fire.
- Toxic risk or risk of fire in the event of leakage.

PROTECTIVE MEASURES:



Collection and packaging:

- Gas cylinders must conform to regulations.
- Spray cans that are completely empty may be placed in black bags if the bags are not intended for incineration.

Storage and transport:

Both full and empty gas cylinders must be secured to prevent falling.

Treatment and final disposal:

1. Gas cylinders must be returned to the supplier for recycling or refilling.
2. Any aerosol spray cans which the supplier does not take back must be completely emptied and disposed of along with household refuse. They must not be incinerated.

DATA SHEET 11

RADIOACTIVE WASTE (CATEGORY 5)

Since radioactive waste is not covered in this manual, brief information is set out below.

Radioactive substances are genotoxic. In the health-care context they are used for *in vitro* analysis of tissue, in diagnostic imaging, in various therapeutic procedures (nuclear medicine), and in various diagnostic practices; they are also used in research laboratories. In most cases the sources are unsealed liquids (such as Tc-99m, P-32, I-125, and I-131).

The waste consists of leftover radioactive liquids, items that have been contaminated with those liquids, and the excreta of patients who have been treated or diagnosed with radionuclides.

Radioactive medical waste is disposed of in accordance with the national legislative provisions on radiation protection. It is classified according to level of radioactivity and half-life. Given the short half-life of most of the radionuclides used in hospitals (6 hours to 60 days), radioactive medical waste is stored on-site until it is considered to be inactive. There are stringent regulations on storage and marking.

See following publications for further information:
WHO, *Safe management of wastes from health-care activities*, 2010. *Op. cit.*

International Atomic Energy Agency (IAEA), *Clearance of materials resulting from the use of radionuclides in medicine, industry and research*, Vienna, 1998.

ANNEX 2

METHOD DATA

SHEETS

DATA SHEET 12: CHOOSING SHARPS CONTAINERS

DATA SHEET 13: BURIAL PIT

DATA SHEET 14: BURIAL PIT FOR ANATOMICAL WASTE

DATA SHEET 15 : SHARPS PIT



DATA SHEET 12

CHOOSING SHARPS CONTAINERS

BRIEF DESCRIPTION:

collection receptacles for needles and other sharps (category 1).

EXAMPLES:

single-use incinerable collection receptacles.

Other options:

- recycled receptacles
- strong cardboard boxes

NOT COVERED IN THIS DATA SHEET:

Devices for destroying or sterilizing needles are not dealt with in this data sheet.

Criteria for choosing sharps containers:

- Resistance to puncture and leakage.
- Resistance to falls, including maintained waterproofness.
- Capacity and insertion opening suited to the various types of waste to be disposed of.
- Ease of inserting the waste with just one hand.
- Presence of mismatch notches (for needle removal, if it is impossible to dispose of the needle without removing it from the syringe).
- Visualization of fill height.
- Tamper-proof system for permanent closure.
- Stability and mounting bracket.
- Existence of a carrying handle.
- Clear indication of hazard by colour code or a "Risk of infection" pictogram.
- Ease of storage.

- Of little use for other purposes.
- Involving no risk for people, animals or the environment during disposal.
- Possibility of complete incineration in which toxic emissions are limited (no PVC).

Other aspects to be taken into consideration:

- It is preferable not to have a lot of different types of collection receptacles in the same hospital.
- Use single-use containers as far as possible, since emptying re-usable containers entails a high risk of accident.
- Whenever the hospital has a single-chamber incinerator, strong cardboard containers are a good choice.

DATA SHEET 13

BURIAL PIT

SOURCE:

WHO website - Health Care Waste <http://www.healthcare-waste.org/en/technical.html?id=111>

The choice of site is important (at least 50 - 100 meters away from any water source according to land/soil characteristics).

| | |
|------------------------|--|
| Annual capacity | 1,200 kg |
| Lifespan | 5 years |
| Dimensions | 3 x 2 x 2 m |
| Drawbacks | <ul style="list-style-type: none">→ Unsuitable for areas subject to heavy rains or flooding.→ Unsuitable if the water table is near the surface (<1.5-2m).→ Difficult and dangerous to build in sandy areas.→ The waste volume is not reduced.→ Requires supervision and surveillance to prevent scavenging. |
| Advantages | <ul style="list-style-type: none">→ Simple and inexpensive. |
| Best practices | <ul style="list-style-type: none">→ The waste should be covered with a layer of soil (5-10 cm). In the event of an epidemic, it should be covered with lime.→ When the pit has been filled to 50 cm from the top, it should be closed with soil or cement. The area should be marked.→ A protective barrier should be erected to limit access for animals, children or scavengers. |

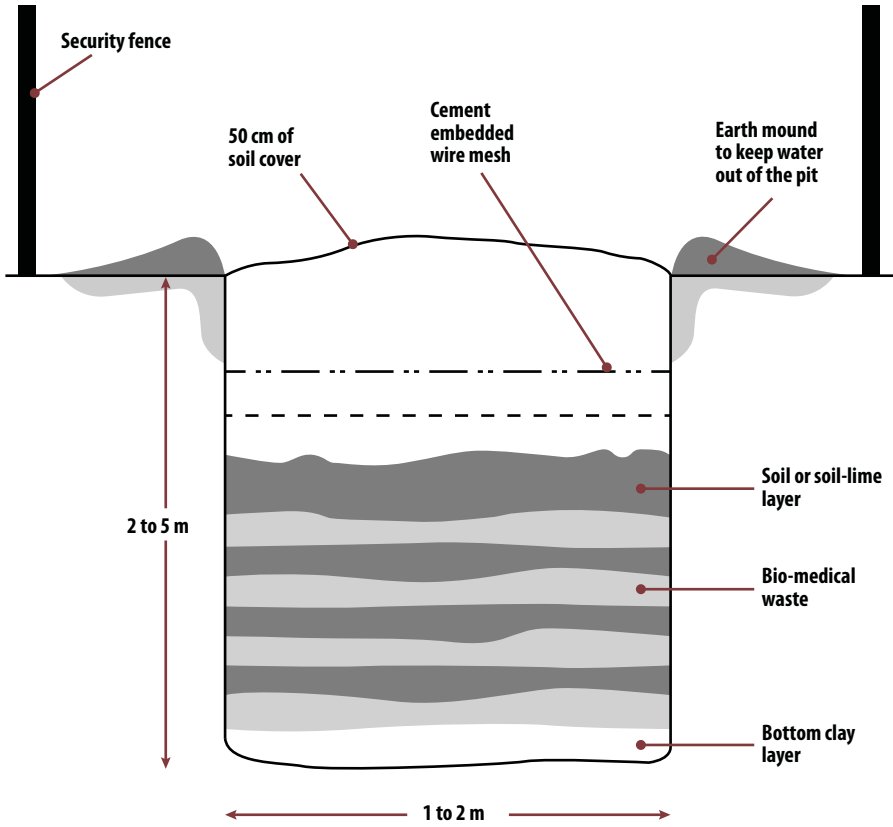

DATA SHEET 14

BURIAL PIT FOR ANATOMICAL WASTE

SOURCE:

WHO website - Health Care Waste <http://www.healthcare-waste.org/en/technical.html?id=110>

These burial pits are used for organic waste such as placentas. The choice of site is important (should not be too close to housing due to odour).

| | |
|------------------------|---|
| Annual capacity | 1,200 kg |
| Lifespan | 5 years |
| Dimensions | 3 x 2 x 2 m |
| Drawbacks | <ul style="list-style-type: none">→ Unsuitable for areas subject to heavy rains or flooding.→ Unsuitable if the water table is near the surface (<1.5-2m).→ Odour. |
| Advantages | <ul style="list-style-type: none">→ Offers good security for the disposal of anatomical waste.→ Simple and inexpensive. |
| Best practices | <ul style="list-style-type: none">→ The waste is inserted through the opening. The loading chute is removed when the pit is almost full. Concrete or a mixture of cement, lime and water is poured in through the opening.→ The area must be marked. |

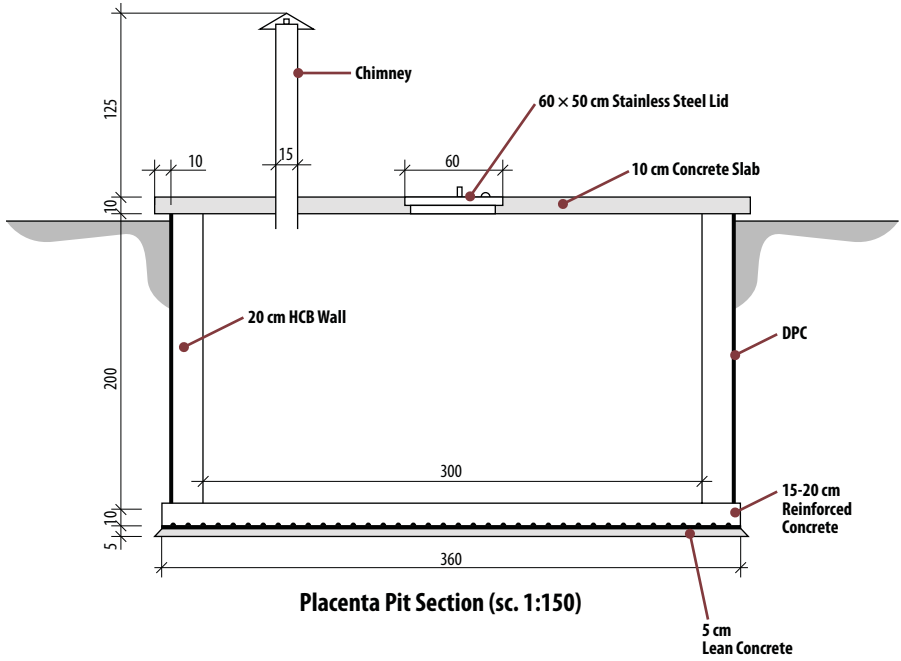

DATA SHEET 15

SHARPS

PIT

SOURCE:

WHO website - Health Care Waste

<http://www.healthcarewaste.org/en/technical.html?id=37>

| | |
|------------------------|--|
| Annual capacity | 480 kg |
| Lifespan | 5 years |
| Dimensions | 1m x 1m x 1.4m |
| Drawbacks | <ul style="list-style-type: none">→ Unsuitable for areas subject to heavy rains or flooding.→ Unsuitable if the water table is near the surface.→ The waste volume is not reduced.→ The loading chute can break accidentally. |
| Advantages | <ul style="list-style-type: none">→ Offers good security for the disposal of sharps.→ Simple and inexpensive. |
| Best practices | The sharps are inserted through the opening. The loading chute is removed when the pit is almost full. Concrete or a mixture of cement, lime and water is poured in through the opening. The area must be marked. |
| N.B.: | Instead of using concrete, it could be of interest to use an HDPE (high-density polyethylene) tank. |

Sharps pit (MSF style)

Note:

If the pit is above the water table, leave drainage holes in the wall.

If the the water table is higher than the base of the pit, coat the inside of the wall with cement to stop water from entering the pit.

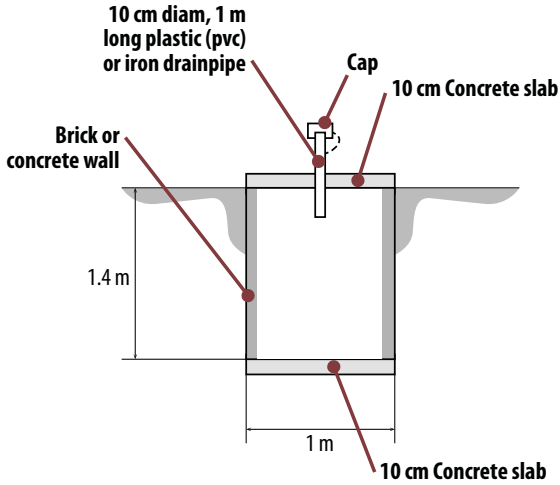
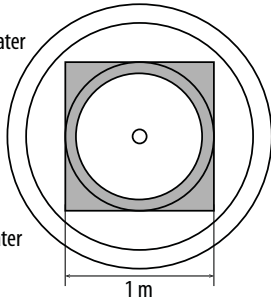

ANNEX 3 TOOLS FOR IMPLEMENTING THE WASTE MANAGEMENT PLAN

ANNEX 3.1: EXAMPLE OF A FORM FOR QUANTIFYING WASTE GENERATION

**ANNEX 3.2: CHECKLIST FOR DESCRIBING THE CURRENT SITUATION
AND THE OPTIONS**

ANNEX 3.3: EXAMPLE OF A WASTE FLOW DIAGRAM (LOKICHOKIO, KENYA, 2001)

ANNEX 3.4: AUDIT CHECKLIST

ANNEX 3.5: INTERNATIONAL TRANSPORT OF DANGEROUS SUBSTANCES BY ROAD

ANNEX 3.6: EXAMPLE OF A POSTER: WHAT TO DO IN THE EVENT OF AEB

Annex 3.1 Example of a form for quantifying waste generation

| N° | Types / Quantities (kg/day) | Operating theatre | Wards | Public areas | Radiology | Admin | Laundry | Kitchen | Total kg/day |
|-----------------------------|--|-------------------|-------|--------------|-----------|-------|---------|---------|--------------|
| | Household refuse | | | | | | | | |
| | Plant waste, kitchen waste | | | | | | | | |
| 1 | Sharps | | | | | | | | |
| 2a | Wastes entailing risk of contamination | | | | | | | | |
| 2b | Anatomical waste | | | | | | | | |
| 2c | Infectious waste | | | | | | | | |
| 3a | Pharmaceutical waste | | | | | | | | |
| 3c | Waste containing heavy metals | | | | | | | | |
| 3d | Chemical waste | | | | | | | | |
| 4 | Pressurized containers | | | | | | | | |
| Total kg/day | | | | | | | | | |
| Total kg/day/patient | | | | | | | | | |

Annex 3.2 **Checklist for describing the current situation****Date:****Filled in by:****Post:**

| 1. | Description of the hospital | |
|-----|---|--|
| 1.1 | Name and location of the hospital: | |
| 1.2 | Number of patients: | |
| 1.3 | Number of out-patients: | |
| 1.4 | Total number of beds: Per specialty | |

| 2. | Sorting, collection, storage and transport | Description of the current situation |
|-------------|---|---|
| 2.1 | Household refuse | |
| 2.2 | Plant waste, kitchen waste | |
| 2.3 | Sharps | |
| 2.4 | Wastes entailing risk of contamination | |
| 2.5 | Anatomical waste | |
| 2.6 | Infectious waste | |
| 2.7 | Pharmaceutical waste | |
| 2.8 | Waste containing heavy metals | |
| 2.9 | Chemical waste | |
| 2.10 | Pressurized containers | |

| 3. | Staff | Name, qualifications, training |
|-----|---|--------------------------------|
| 3.1 | Is someone responsible for waste? | |
| 3.2 | Who are the persons involved in handling, collecting, storing and transporting waste? | |

| 4. | Waste policy | Description |
|-----|--|-------------|
| 4.1 | Are there any national legislative provisions on waste management? If so, what are they? | |
| 4.2 | Is there any national waste management plan? | |
| 4.3 | Is there any waste management plan in the health facility itself? | |
| 4.4 | What is the local practice regarding anatomical waste? | |
| 4.5 | At what depth is the water table? | |
| 4.6 | Is any budget allocated to waste management? | |

| 5. | Treatment - disposal | Description |
|-----|--|-------------|
| 5.1 | Is the waste treated on-site? If so, how? | |
| 5.2 | Is the waste treated off-site? If so, by whom and how ? Is there any waste treatment facility at the regional level? Is there a landfill in the vicinity? | |
| 6. | Training | |
| 6.1 | Has any waste management training been set up for the hospital staff? | |
| 6.2 | Has any waste management training been set up at the regional or national level? | |

| 7. | Protective measures | |
|-----|---|--|
| 7.1 | Do the people who handle waste have PPE at their disposal? If so, what equipment is available to them? Is it appropriate? Is it worn? | |
| 7.2 | Are personal hygiene facilities available (wash basins, showers)? Do they work? | |
| 7.3 | Have all of the staff been vaccinated against hepatitis A and B and tetanus? | |
| 7.4 | Is there a procedure for dealing with AEB or spills? | |

Annex 3.3 **Example of a waste flow diagram**²⁹

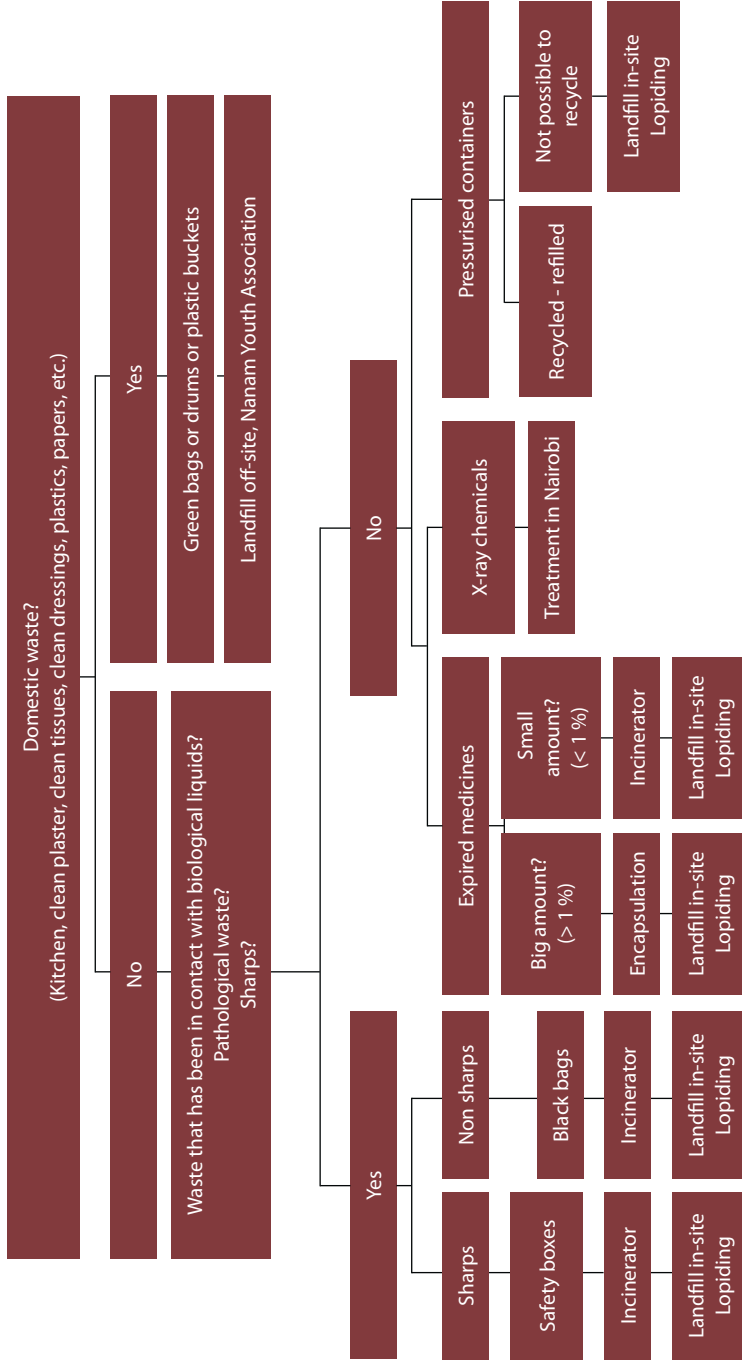

29 S.Praplan, Hospital waste management in Lopiding surgical hospital, Lokichokio, Kenya, Evaluation report, ICRC, 2001.

Annex 3.4 **Audit checklist****Date:****Filled in by:****Post:**

→ Y = yes

→ N = no

→ SE = to some extent

→ NA = does not apply

| 1. | General issues | Y/N/SE/NA | Comments, measures to be taken |
|-----|---|-----------|--------------------------------|
| 1.1 | Is the working group operational? Are the definitions of the duties of each group member updated? | | |
| 1.2 | Is the reporting on waste quantities carried out correctly? Has there been a significant increase in the quantity of waste generated? If so, why? | | |
| 1.3 | Are the resources provided sufficient for implementing the waste management plan? | | |
| 1.4 | Is the situation at the national level still the same? Is there a new national or regional waste management plan? | | |

| 2. | Minimization | Y/N/SE/NA | Comments, measures to be taken |
|-----|---|-----------|-----------------------------------|
| 2.1 | Is care being taken to implement the waste minimization policy - i.e. to reduce the quantity of waste generated at source (less packaging, returning containers to the supplier, reusable equipment)? | | |
| 2.2 | Is care being taken to avoid re-using needles and syringes? | | |
| 2.3 | Is purchasing policy with a view to minimizing hazardous wastes being applied – i.e. PVC-free and mercury-free supplies, choice of less toxic substances, safe injection equipment? | | |
| 2.4 | Are the following wastes recycled: paper, glass, metals, PET plastic, plant waste, photographic developers? | | |
| 2.5 | Is the purchasing of chemicals and drugs centralized? Is stock management satisfactory (has the quantity of expired or unused drugs been reduced?) | | |

| 3. | Sorting waste | Y/N/SE/NA | Comments, measures to be taken |
|-----|---|-----------|--------------------------------|
| 3.1 | Is each type of waste clearly identified by a colour code or symbol? | | |
| 3.2 | Are there containers and bags everywhere where waste is generated? | | |
| 3.3 | Are there sharps containers everywhere where this type of waste is generated? | | |
| 3.4 | Does the nursing staff take a sharps container to the patient's bedside? | | |
| 3.5 | In the sharps container, are the needles connected to the syringes, without the needle cap? | | |
| 3.6 | Is sorting carried out effectively throughout the chain (from waste production to storage)? | | |
| 3.7 | Is household refuse separated from hazardous waste at source? | | |
| 3.8 | Are all members of staff reminded about sorting waste? | | |

| | | | |
|-------------|--|--|--|
| 3.9 | Are checks carried out regularly? | | |
| 3.10 | Is anatomical waste treated in accordance with local customs? | | |
| 3.11 | Do the bags that have been chosen meet the criteria set out in this manual (PVC-free, strong, appropriate size?) | | |
| 3.12 | Do the sharps containers meet the criteria listed in data sheet 12? | | |
| 3.13 | Are there adequate stocks of bags and containers? | | |
| 3.14 | Are the bags handled correctly (handler wearing gloves, bags closed when 2/3 full and grasped from the top, no piling of bags, no emptying of bags)? | | |

| 4. | Collection and storage | Y/N/SE/NA | Comments, measures to be taken |
|-----|---|-----------|--------------------------------|
| 4.1 | Is the waste collected regularly? | | |
| 4.2 | Are the persons in charge of collecting waste informed that they must take yellow bags and sharps containers only when they have been closed? | | |
| 4.3 | Do they wear gloves? | | |
| 4.4 | Are the bags that have been collected replaced immediately with new bags? | | |
| 4.5 | Is the storage time for category 2 waste limited to 48h? | | |
| 4.6 | Does the storage facility meet the requirements (closed, covered, cleaned regularly, protected from animals, well aired and well lit, etc.)? See Chapter 8. | | |

| 5. | Transport | Y/N/SE/NA | Comments, measures to be taken |
|-----|--|-----------|-----------------------------------|
| 5.1 | Are there means of conveyance/transport reserved for medical waste? Are separate means used for each type of waste? | | |
| 5.2 | Do they meet the requirements (easy to load and unload, no sharp corners, easy to clean)? | | |
| 5.3 | Do the off-site transport vehicles meet the requirements (closed, load secured, marked with signs) | | |
| 5.4 | Are the means of conveyance/transport cleaned regularly? | | |
| 5.5 | During on-site transportation, do collection rounds respect clean/sensitive areas? | | |
| 5.6 | For off-site transport, is the waste correctly packaged and labelled? | | |
| 5.7 | Is the carrier authorized to transport dangerous substances? | | |
| 5.8 | Do the consignment notes meet the statutory requirements? | | |

| 6. | Treatment and final disposal | Y/N/SE/NA | Comments, measures to be taken |
|-----|--|-----------|--------------------------------|
| 6.1 | Is the waste treated off-site in an appropriate infrastructure? If it is, go to Question 6.2. If it is not, go to Question 6.3. | | |
| 6.2 | Have the treatment methods been assessed in terms of environmental protection and health protection? If they have, go to Question 7.1. | | |
| 6.3 | Have on-site pre-treatment, treatment and disposal methods been opted for? | | |
| 6.4 | Has their impact on the environment and on staff health been reduced to a minimum? | | |
| 6.5 | Have options other than incineration been examined? | | |

| | | | |
|------------|--|--|--|
| 6.6 | Where a small on-site incinerator is used, is care taken to reduce emissions as far as possible (good design, good operating practices, suitable place, regular maintenance, training for operators, emission control)? | | |
| 6.7 | Is particular attention paid to the treatment of sharps and highly infectious wastes (lab cultures, wastes from care of infectious patients)? Are these wastes rendered harmless and unusable before being transported off-site? | | |

| 7. | Staff protection measures | Y/N/SE/NA | Comments, measures to be taken |
|-----|--|-----------|--------------------------------|
| 7.1 | Are regular checks carried out to ensure that protective measures are taken? | | |
| 7.2 | Is the PPE appropriate for the activity concerned, and is it worn correctly? | | |
| 7.3 | Do employees wear gloves regularly when in contact with waste? | | |
| 7.4 | Do employees in contact with waste wash their hands properly and regularly? | | |
| 7.5 | Have all staff members been vaccinated against hepatitis A and B and tetanus? | | |
| 7.6 | Is there a system for dealing with accidents involving exposure to blood or other body fluids (posters/notices concerning the measures to be taken, post-accident care, registration)? | | |
| 7.7 | Is every staff member aware of the emergency measures to be taken in the event of an accident, spilling, or splashing/spraying? | | |

| 8. | Training | Y/N/SE/NA | Comments, measures to be taken |
|------------|---|------------------|---|
| 8.1 | Has the ICRC developed any training material, or is external training material available? | | |
| 8.2 | Have all staff members been trained? Are courses held for new staff members and whenever changes are made in the waste management plan? | | |
| 8.3 | Is the content of the training adjusted to suit each category of staff? | | |

Annex 3.5 **International transport of dangerous goods by road**

The off-site transport of dangerous goods must comply with national legislation and international agreements. In the absence of national legislation, the UN recommendations on the transport of dangerous goods (United Nations model regulations)³⁰ or the European Agreement concerning the International Carriage of Dangerous Goods by Road (ADR)³¹ should be taken as the reference.

Classification

The UN has given the various types of dangerous substances code numbers. There are almost 3000 such numbers. The substances in class 6.2 (infectious materials) are sub-divided as follows:

Table A3.5.1 **Examples of UN numbers**

| Infectious substance | UN code no. | Description of the substance |
|--|--------------------|---|
| Infectious substances affecting man | 2814 | Infectious substances entailing a hazard for man |
| Infectious substances affecting man | 2900 | Infectious substances entailing a hazard only for animals |
| Clinical wastes | 3291 | Unspecified clinical wastes |
| Diagnostic samples | 3373 | Diagnostic samples |

Highly infectious waste (category 2.c in this manual) corresponds to UN 2814, and waste entailing risk of contamination corresponds to UN 3291. UN 2814 wastes should be treated on-site.

³⁰ http://www.unece.org/trans/danger/publi/unrec/rev16/16files_f.html

³¹ <http://www.unece.org/trans/danger/publi/adr/adr2009/09ContentsE.html>

Packaging

The entity producing the waste is responsible for the safe packaging and labelling of that waste. Medical waste that is transported off-site must be labelled in accordance with the national legislation. The UN recommends the following information for class 6.2:

- waste category;
- date of collection;
- place where collected;
- UN class (6.2) / year in which packaged;
- UN no. (e.g. 3291) and name of the substance (in this case, unspecified clinical wastes);
- international hazard symbol (infectious);
- total quantity;
- name of producer;
- destination.

Furthermore, infectious medical waste must be packed in containers with the following features:

- they must be durable and water-proof;
- the dominant colour must be yellow, and they must be labelled as required;
- they must have a provisional and a permanent closing system.

Transport personnel

The carrier must be authorized to handle special wastes. The transport personnel must be trained as to the risks involved and the precautions to be taken when handling the substances that are being transported (also in the event of an accident). The personnel must carry emergency telephone numbers in their vehicles.

Vehicle placarding

Vehicles carrying hazardous medical waste must be marked with various placards including “hazard code” and “hazard symbol” plates (see Figure A3.5.2). Hazard code plates are orange and are divided into two parts. The top part contains the 2-digit or 3-digit hazard code (Kemler code). The first digit represents the principal risk. There is always a second digit representing the subsidiary risk (0 where there is none). There may be a third digit indicating a subsidiary risk, as the case may be. In the case of hospital waste the number is 62. The bottom part of the plaque contains the substance number, which is the UN number under which the type of substance transported is referenced. The hazard symbol plate contains the pictogram representing the type of risk entailed by the substance carried; there are nine such symbols (see Table A3.5.3).

Figure A3.5.2 **Example of a notice giving hazard code and symbol for medical waste entailing danger of contamination (category 2.a in this manual)**









Hazard code



Hazard symbol

If the vehicle is carrying less than 333 kg of medical waste (UN no. 3291), placarding is optional.

Table A3.5.3 **Examples of UN hazard categories**

| | | |
|-----|---|---|
| 1 | Explosive substances or articles |  |
| 3 | Flammable liquids |  |
| 6.1 | Toxic substances |  |
| 6.2 | Infectious substances |  |
| 7 | Radioactive material |  |
| 8 | Corrosive substances |  |
| 9 | Miscellaneous dangerous substances and articles |  |

Consignment notes

The carrier must hold an official document (consignment form – see Table A3.5.4). At the end of the transport procedure he must fill in his part of the form and return the document to the entity that produced the waste.

Table A3.5.4 **Examples of consignment notes pursuant to the ADR**

| | |
|---|------------------|
| Disposal of waste from health-care activities with risk of infection | 4 pages ref 3817 |
| Disposal of human body parts | 4 pages ref 3819 |

Annex 3.6 **Example of a poster:**
What to do in the event of AEB

(Source: GERES, *Prévention et prise en charge des AES*, 2008; Hôpital national de Niamey, July 2007)

WHAT TO DO AFTER AN AEB

Immediately:

- If possible, **stop the current action**, after making sure that the patient is safe.
- **Do not induce bleeding.**
- **Clean the wound with soap and water.**
- **Disinfect the wound with freshly diluted bleach* for at least 5 minutes** (if the eye or a mucous membrane is affected, rinse with water or physiological serum).
- **Report the accident to the medical officer**, who will enter it in the logbook of the nursing department.
- The victim of the accident is given an **anonymous number**, which is filled in on the questionnaire on the circumstances of the AEB and, if necessary, on blood samples and the lab results.
- The medical officer gives the AEB victim the list of prescribing doctors.
- **Contact a prescribing doctor immediately (within 4 hours).**
- **The doctor** will decide whether or not to carry out a test, **with your consent.**
- After assessing the risk, the **doctor** will propose **treatment.**









*Bleach dilution used exclusively for disinfecting the skin: put a capful of 2.6% bleach solution into a receptacle and add 4 capfuls of water.

ANNEX 4
LIST OF
SYMBOLS
AND PICTOGRAMS

Prohibition signs³²

| | | | |
|---|------------------------|---|-----------------------|
|  | No unauthorized access |  | No eating or drinking |
|  | Do not touch | | |

Warning signs and hazard or risk signs³²

| | | | |
|---|--------------------------------|---|---------------------|
|  | Toxic substances |  | General risk |
|  | Corrosive substances |  | Oxidizing substance |
|  | Harmful or irritant substances |  | Explosion risk |
|  | Biological risk |  | Fire risk |

³² According to European Directive 92/58/EEC concerning the minimum requirements for the provision of safety and/or health signs at work

Mandatory signs³²





| | | | |
|---|---|---|--------------------------------|
|  | Wear gloves (compulsory) |  | Wear goggles (compulsory) |
|  | Wear boots (compulsory) |  | Wash your hands |
|  | Wear protective clothing (compulsory) |  | Protect respiratory airways |

Labelling of chemicals³³

| | | | |
|---|-----------|---|---------------------|
|  | Corrosive |  | Harmful or irritant |
|  | Flammable |  | Toxic |

33 Danger symbols and signs according to European Directive EU 67/548/EEC

Labelling of chemicals³⁴

| | | | |
|---|--|---|--|
|  | <p>SGH05: corrosive properties</p> |  | <p>SGH06: small or very small quantities are fatal or have acute and serious effects on the health</p> |
|  | <p>SGH02: flammable</p> |  | <p>SGH07: various effects on the health (redness on the skin, irritation, skin allergies, etc.)</p> |
|  | <p>SGH08: may have serious chronic effects on the health</p> | | |

³⁴ According to the Globally Harmonized System (international regulations).

LIST OF TABLES AND FIGURES

| | | |
|-------------------|---|----|
| TABLE 2.1 | Classification of hazardous medical waste | 13 |
| TABLE 3.1 | Examples of infections that can be caused by hazardous medical waste | 18 |
| TABLE 3.2 | Examples of the survival time of certain pathogens | 20 |
| FIGURE 3.1 | Example of the labelling of chemicals (European system applicable until 2015) | 22 |
| FIGURE 3.2 | Example of the labelling of chemicals according to the new (international) system (GHS) | 23 |
| TABLE 5.1 | Tools for drafting the waste management plan | 38 |
| TABLE 7.1 | Coding recommendations (WHO – UNEP/SBC 2005) | 47 |
| TABLE 10.1 | Suitability of treatment techniques by type of waste | 60 |
| FIGURE 10.1 | Example of a diagram intended as a guide for deciding on the treatment/disposal methods to be used in the absence of appropriate regional infrastructures | 61 |
| FIGURE 10.2 | The principle of De Montfort incinerators (Pr. D.J.Picken) | 63 |
| TABLE 10.2 | Advantages and drawbacks of incineration | 66 |

| | | |
|----------------------|---|-----|
| TABLE 10.3 | Advantages and drawbacks of chemical disinfection | 69 |
| TABLE 10.4 | Advantages and drawbacks of steam disinfection | 71 |
| TABLE 10.5 | Advantages and drawbacks of needle extractors and destroyers | 72 |
| TABLE 10.6 | Advantages and drawbacks of shredders | 73 |
| TABLE 10.7 | Advantages and drawbacks of encapsulation | 74 |
| TABLE 10.8 | Advantages and drawbacks of disposal by burial | 76 |
| TABLE 10.9 | Permissible limits in force in Switzerland (Decree on water protection, Switzerland) | 77 |
| TABLE 11.1 | Personal protective equipment (PPE) | 82 |
| TABLE 11.2 | Risk of transmission of infection after percutaneous exposure to contaminated blood | 85 |
| TABLE A3.5.1 | Examples of UN numbers | 145 |
| FIGURE A3.5.2 | Example of a notice giving hazard code and symbol for medical waste entailing danger of contamination (category 2.a in this manual) | 147 |
| TABLE A3.5.3 | Examples of UN hazard categories | 148 |
| TABLE A3.5.4 | Examples of consignment notes pursuant to the ADR | 149 |

LIST OF ABBREVIATIONS

| | |
|------|---|
| ADR | European Agreement concerning the International Carriage of Dangerous Goods by Road |
| AEB | Accidental exposure to blood |
| CIRC | Centre international de recherche sur le cancer, Lyon |
| GAVI | Global Alliance for Vaccines and Immunization |
| GHS | Globally Harmonized System (of Classification and Labelling of Chemicals) |
| IAEA | International Atomic Energy Agency, Vienna |
| IARC | International Agency for Research on Cancer |
| ICRC | International Committee of the Red Cross |

| | |
|------|--|
| ISWA | International Solid Waste Association |
| PATH | Program for Appropriate Technology in Health |
| PCB | Polychlorinated biphenyls |
| PE | Polyethylene |
| PET | Polyethylene terephthalate |
| POP | Persistent organic pollutants |
| PP | Polypropylene |
| PPE | Personal protective equipment |
| PVC | Polyvinyl chloride |
| SBC | Secretariat of the Basel Convention |
| SDS | Safety data sheet |
| UNEP | United Nations Environment Programme |
| WHO | World Health Organization |

MISSION

The International Committee of the Red Cross (ICRC) is an impartial, neutral and independent organization whose exclusively humanitarian mission is to protect the lives and dignity of victims of armed conflict and other situations of violence and to provide them with assistance. The ICRC also endeavours to prevent suffering by promoting and strengthening humanitarian law and universal humanitarian principles. Established in 1863, the ICRC is at the origin of the Geneva Conventions and the International Red Cross and Red Crescent Movement. It directs and coordinates the international activities conducted by the Movement in armed conflicts and other situations of violence.



ICRC